

SR22T

WITH 3600 POUND TAKEOFF WEIGHT AND FLIGHT INTO KNOWN ICE SYSTEM



Quick Reference Checklist

for

SR22T Aircraft Serials 0442T and Subsequent with 3600 Pound Take-off Weight and Flight Into Known Ice System



The procedures in this publication are abbreviated and derived from procedures in the FAA Approved Airplane Flight Manual and Pilot's Operating Handbook (POH) P/N 13772-005 Revision 1. These procedures do not supersede the procedures in the POH. In the event of conflict, the POH shall take precedence.

CIRRUS PILOT'S CHECKLIST MODEL SR22T

**Normal Procedures
Table of Contents**

Primary Flight DisplayN-1
 Airspeeds for Normal OperationN-2
 Preflight InspectionN-3
 Before Starting EngineN-9
 Starting EngineN-9
 Cold Weather Operation: StartingN-10
 Before TaxiingN-10
 TaxiingN-10
 Before TakeoffN-11
 Normal TakeoffN-13
 Short Field Takeoff.....N-13
 Full Power Climb: Rich of Peak Technique.....N-13
 Cruise Climb: Lean of Peak TechniqueN-13
 Icing Conditions: In Flight.....N-14
 If Icing Conditions ExistN-14
 Inadvertent Icing Encounter.....N-14
 Icing Conditions: In Flight.....N-15
 While in Icing ConditionsN-15
 After Leaving Icing ConditionsN-15
 Cruise.....N-15
 Descent.....N-16
 If Icing Conditions ExistN-16
 Before Landing.....N-17
 Normal Landing.....N-17
 Short Field Landing.....N-17
 Balked Landing/Go-Around.....N-17
 After Landing.....N-18
 ShutdownN-18
 Oxygen Duration (Precise Flight System).....N-19

CIRRUS PILOT'S CHECKLIST MODEL SR22T

Primary Flight Display

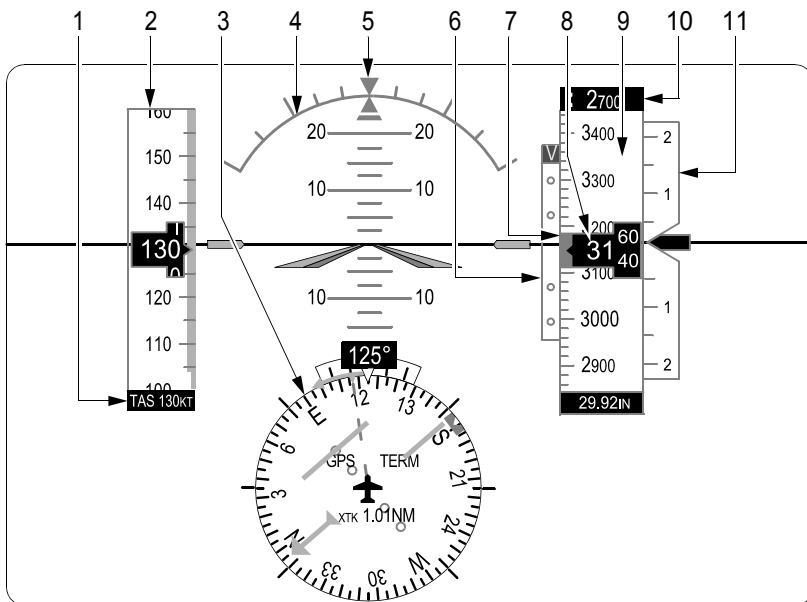

LEGEND

- 1. True Airspeed
- 2. Airspeed Indicator
- 3. Horizontal Situation Indicator (HSI)
- 4. Attitude Indicator
- 5. Slip/Skid Indicator
- 6. Vertical Deviation Indicator (VDI)
- 7. Selected Altitude Bug
- 8. Current Altitude
- 9. Altimeter
- 10. Selected Altitude
- 11. Vertical Speed Indicator (VSI)
- 12. Current Heading
- 13. Lubber Line
- 14. Selected Heading Bug
- 15. Flight Phase
- 16. Navigation Source
- 17. Aircraft Symbol
- 18. Course Deviation Scale
- 19. Rotating Compass Rose
- 20. Course Pointer

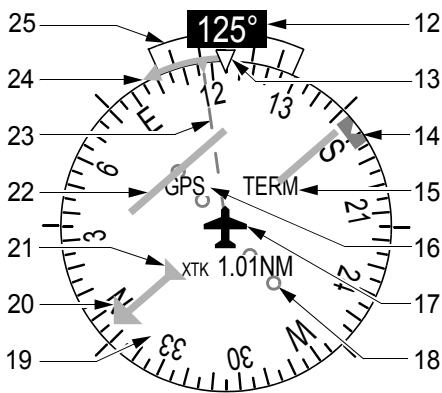

HSI DETAIL

- 21. Turn Rate/Heading Trend Vector
- 22. Course Deviation Indicator
- 23. Current Track Indicator
- 24. Turn Rate/Heading Trend Vector
- 25. Turn Rate Indicator

SR22_FM07_2790

CIRRUS PILOT'S CHECKLIST MODEL SR22T

Airspeeds for Normal Operation

Takeoff Rotation:

- Normal, Flaps 50% 77 KIAS
- Obstacle Clearance, Flaps 50% 85 KIAS

Enroute Climb, Flaps Up:

- Best Rate of Climb, SL 103 KIAS
- Best Rate of Climb, 10,000 102 KIAS
- Best Angle of Climb, SL 88 KIAS
- Best Angle of Climb, 10,000 88 KIAS
- Normal, Full Power, Full Rich Climb 120 KIAS

Landing Approach:

- Normal Approach, Flaps Up 90-95 KIAS
- Normal Approach, Flaps 50% 85-90 KIAS
- Normal Approach, Flaps 100% 80-85 KIAS
- Short Field, Flaps 100% (V_{REF}) 79 KIAS

Go-Around, Flaps 50%:

- Full Power 80 KIAS

Maximum Recommended Turbulent Air Penetration:

- 3600 lb 140 KIAS
- 2900 lb 123 KIAS

Maximum Demonstrated Crosswind Velocity:

- Takeoff or Landing 21 Knots

Anti-Ice System:

- Minimum Airspeed For FIKI Conditions 95 KIAS*
**Includes all phases of flight, including approach, except as required for takeoff and landing.*
- Max Airspeed Anti-Ice System Ops 177 KIAS and 204 KTAS
- Recommended Holding Airspeed 120 KIAS

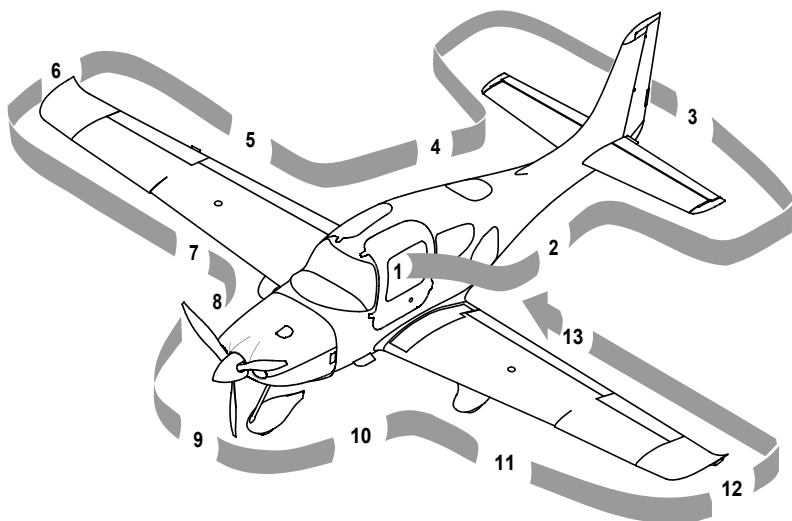

SR22_FM04_1454

Preflight Inspection

1. Cabin
 - a. Required Documents On Board
 - b. Avionics Power Switch OFF
 - c. Bat 2 Master Switch ON
 - d. PFD Verify On
 - e. Essential Bus Voltage 23-25 Volts
 - f. Flap Position Light OUT
 - g. Battery 1 Master Switch ON
 - h. Avionics Cooling Fan Audible
 - i. Oxygen Masks/Cannulas and Hoses Check Condition
 - j. Oxygen System ON
 - (1) Quantity Verify adequate supply for flight with reserve
 - (2) Flow Check flowmeter on all masks
 - (3) Oxygen System OFF
 - k. Lights Check Operation

(Continued on following page)

CIRRUS PILOT'S CHECKLIST MODEL SR22T

- l. Stall Warning Test
- m. Fuel Quantity Check
- n. Fuel Selector Select Fullest Tank
- o. Flaps 100%, Check Light ON
- p. Bat 1 and 2 Master Switches OFF
- q. Circuit Breakers..... In
- r. Avionics Master Switch ON
- s. Cabin Speaker ON
- t. Cabin Doors Close
- u. WIND SHLD Push-Button Press
 - (1) Verify evidence of deicing fluid from spray nozzles.
- v. PUMP BKUP Switch ON
 - (1) Metering Pump Duty Cycle Verify Continuously ON
 - (2) Deicing Fluid and Endurance Indications Check
- w. ICE PROTECT Mode Switch HIGH
 - (1) Metering Pump Duty Cycle Verify Continuously ON
 - (2) Deicing Fluid and Endurance Indications Check
- x. PUMP BKUP Switch OFF
- y. ICE PROTECT System Switch ON
- z. ICE PROTECT Mode Switch NORM
 - (1) Metering Pump Duty Cycle Verify 30s ON, 90s OFF
 - (2) Deicing Fluid and Endurance Indications Check
- aa. PUMP BKUP Switch ON
 - (1) Metering Pump Duty Cycle Verify Continuously ON
 - (2) Deicing Fluid and Endurance Indications Check
- ab. PUMP BKUP Switch OFF
- ac. ICE Inspection Lights Switch..... ON
 - (1) Verify LH and RH Operation.
- ad. PITOT HEAT Switch..... ON 45 seconds, then OFF
- ae. ICE PROTECT Mode Switch HIGH
 - (1) Metering Pump Duty Cycle Verify Continuously ON
 - (2) Deicing Fluid and Endurance Indications Check

(Continued on following page)

CIRRUS PILOT'S CHECKLIST MODEL SR22T

- af. Fire Extinguisher Charged and Available
- ag. Emergency Egress Hammer Available
- ah. CAPS Handle Pin Removed
2. Left Fuselage
- a. Door Lock..... Unlock
- b. COM 1 Antenna (top)..... Condition and Attachment
- c. Transponder Antenna (underside) .. Condition and Attachment
- d. Wing/Fuselage Fairing Check
- e. COM 2 Antenna (underside) Condition and Attachment
- f. Baggage Door Closed and Secure
- g. Static Button Check for Blockage
- h. Parachute Cover Sealed and Secure
3. Empennage
- a. Tiedown Rope Remove
- b. Horizontal and Vertical Stabilizers Condition
- c. Stabilizers Porous Panels Condition / Security
(1) Verify Evidence of Deicing Fluid Along Length of Panels and Elevator Horns.
- d. Elevator and Tab Condition and Movement
- e. Rudder Freedom of Movement
- f. Rudder Trim Tab..... Condition and Security
- g. Attachment hinges, bolts and cotter pins Secure
4. Right Fuselage
- a. Static Button Check for Blockage
- b. Wing/Fuselage Fairings Check
- c. Door Lock..... Unlock
5. Right Wing Trailing Edge
- a. Flap and Rub Strips (if installed) Condition and Security
- b. Aileron and Tab Condition and Movement
- c. Aileron Gap Seal Security
- d. Hinges, actuation arm, bolts, and cotter pins Secure

(Continued on following page)

CIRRUS PILOT'S CHECKLIST MODEL SR22T

- 6. Right Wing Tip
 - a. Tip Attachment
 - b. Strobe, Nav Light and Lens Condition and Security
 - c. Fuel Vent (underside) Unobstructed
- 7. Right Wing Forward and Main Gear
 - a. Leading Edge and Stall Strips Condition
 - b. Fuel Cap Check Quantity and Secure
 - c. Fluid Tank Verify Desired Quantity
 - (1) Filler Cap Condition and Security
 - (2) Fluid Vent (underside) Unobstructed
 - d. Porous Panels Condition and Security
 - (1) Check Evidence of Deicing Fluid Along Length of Panels.
 - e. Lift Transducer Faceplate Perceptibly Hot
 - f. Lift Transducer Vane Very Hot
 - (1) Verify Stall Warning System audio annunciation within 4 seconds after lifting stall vane with wooden tooth pick or tongue depressor.
 - g. Fuel Drains (2 underside) Drain and Sample
 - h. Wheel Fairings Security, Accumulation of Debris
 - i. Tire Condition, Inflation, and Wear
 - j. Wheel and Brakes Fluid Leaks, Evidence of Overheating, General Condition, and Security.
 - k. Chocks and Tiedown Ropes Remove
- 8. Nose, Right Side
 - a. Vortex Generator Condition
 - b. Ice-Inspection Light Condition / Security
 - c. Cowling Attachments Secure
 - d. Exhaust Pipe Condition, Security, and Clearance
 - e. Gascolator (underside) Drain for 3 seconds, Sample
- 9. Nose gear, Propeller, and Spinner
 - a. Tow Bar Remove and Stow
 - b. Strut Condition

(Continued on following page)

CIRRUS PILOT'S CHECKLIST MODEL SR22T

PREFLIGHT

- c. Wheel FairingSecurity, Accumulation of Debris
 - d. Wheel and Tire Condition, Inflation, and Wear
 - e. Propeller Check adequate Ground Clearance
 - f. Spinner Condition, Security, and Oil Leaks
 - g. Slinger Ring Evidence Of Deicing Fluid
 - h. Air Inlets Unobstructed
 - i. Alternator Condition
10. Nose, Left Side
- a. Landing Light Condition
 - b. Engine Oil Check 6-8 quarts, Leaks, Cap & Door Secure
 - c. Cowling Attachments Secure
 - d. External Power Door Secure
 - e. Vortex Generator Condition
 - f. Ice-Inspection Light Condition / Security
 - g. Windshield Spray Nozzles Condition / Security
 - h. Exhaust Pipe(s) Condition, Security, and Clearance
11. Left Wing Forward and Main Gear
- a. Wheel fairingsSecurity, Accumulation of Debris
 - b. Tire Condition, Inflation, and Wear
 - c. Wheel and BrakesFluid Leaks, Evidence of Overheating, General Condition, and Security.
 - d. Chocks and Tiedown Ropes Remove
 - e. Fuel Drains (2 underside) Drain and Sample
 - f. Fuel Cap Check Quantity and Secure
 - g. Fluid Tank Verify Desired Quantity
 - (1) Filler Cap Condition and Security
 - (2) Fluid Vent (underside) Unobstructed
 - h. Leading Edge and Stall Strips Condition
 - i. Porous Panels Condition / Security
 - (1) Check Evidence of Deicing Fluid Along Length of Panels.

(Continued on following page)

CIRRUS PILOT'S CHECKLIST MODEL SR22T

12. Left Wing Tip

- a. Fuel Vent (underside)..... Unobstructed
- b. Pitot Mast (underside)..... Cover Removed, Tube Clear
- c. Pitot Probe (underside)..... Unobstructed
- d. Pitot Probe Very Hot
- e. Strobe, Nav Light and Lens..... Condition and Security
- f. Tip Attachment

13. Left Wing Trailing Edge

- a. Flap And Rub Strips (If installed)..... Condition and Security
- b. Aileron Freedom of movement
- c. Aileron Gap Seal Security
- d. Hinges, actuation arm, bolts, and cotter pins Secure

14. Cabin

- a. Fluid Quantity Verify 5 Gallon Minimum
- b. ICE PROTECT System Switch OFF
- c. Flaps 0%
- d. Battery 1 Master Switch OFF
- e. Avionics Master Switch OFF
- f. Cabin Speaker OFF

CIRRUS PILOT'S CHECKLIST MODEL SR22T

Before Starting Engine

- 1. Preflight Inspection COMPLETED
- 2. Weight and Balance..... Verify within limits
- 3. Emergency Equipment ON BOARD
- 4. Passengers..... BRIEFED
- 5. Seats, Seat Belts, and Harnesses ADJUST & SECURE

Starting Engine

- 1. External Power (If applicable).....CONNECT
- 2. Brakes HOLD
- 3. Bat Master SwitchesON (Check Volts)
- 4. Strobe Lights..... ON
- 5. MixtureFULL RICH
- 6. Power Lever FULL FORWARD
- 7. Fuel PumpBOOST
- 8. Propeller Area..... CLEAR
- 9. Power Lever OPEN ¼ INCH
- 10. Ignition SwitchSTART (Release after engine starts)
- 11. MixtureLEAN
until RPM rises to a maximum value. Leave the mixture in this position during taxi and until run-up.
- 12. Power LeverRETARD (to maintain 1000 RPM)
- 13. Oil Pressure.....CHECK
- 14. Alt Master Switches ON
- 15. Avionics Power Switch..... ON
- 16. Engine Parameters..... MONITOR
- 17. External Power (If applicable).....DISCONNECT
- 18. Amp Meter/Indication.....CHECK

STARTING
ENGINE

CIRRUS PILOT'S CHECKLIST MODEL SR22T

Cold Weather Operation: Starting

1. Ignition Switch OFF
2. Propeller Hand TURN several rotations
3. External Power (If applicable).....CONNECT
4. Brakes HOLD
5. Bat Master Switches.....ON (check voltage)
6. Mixture FULL RICH
7. Power lever..... FULL FORWARD
8. Fuel Pump HIGH BOOST/PRIME, then BOOST
9. Propeller Area..... CLEAR
10. Power Lever OPEN ¼ INCH
11. Ignition SwitchSTART (Release after engine starts)
12. Power Lever RETARD (to maintain 1000 RPM)
13. Oil Pressure CHECK
14. Alt Master Switches ON
15. Avionics Power Switch ON
16. Engine Parameters MONITOR
17. External Power (If applicable).....DISCONNECT
18. Amp Meter/Indication.....CHECK
19. Strobe Lights..... ON

STARTING
TAXI

Before Taxiing

1. Flaps..... UP (0%)
2. Radios/Avionics AS REQUIRED
3. Cabin Heat/Defrost AS REQUIRED
4. Fuel Selector SWITCH TANK

Taxiing

1. Parking Brake DISENGAGE
2. Brakes CHECK
3. HSI Orientation CHECK
4. Attitude Gyro..... CHECK
5. Turn Coordinator CHECK

CIRRUS PILOT'S CHECKLIST MODEL SR22T

Before Takeoff

1. Doors LATCHED
2. CAPS Handle Verify Pin Removed
3. Seat Belts and Shoulder Harness..... SECURE
4. Air Conditioner AS DESIRED

• Caution •

Use of RECIRC mode prohibited in flight.

5. Fuel Quantity CONFIRM
6. Fuel Selector FULLEST TANK
7. Fuel Pump BOOST
8. Mixture FULL RICH
9. Flaps SET 50% & CHECK
10. Transponder SET
11. Autopilot CHECK
12. Navigation Radios/GPS SET for Takeoff
13. Cabin Heat/Defrost AS REQUIRED
14. Brakes HOLD
15. Power Lever 1700 RPM
16. Alternator CHECK
 - a. Pitot Heat ON
 - b. Navigation Lights ON
 - c. Landing Light ON
 - d. Annunciator Lights CHECK
Verify both ALT 1 and ALT 2 caution lights out and positive amps indication for each alternator.
17. Voltage CHECK
18. Pitot Heat AS REQUIRED
19. Navigation Lights AS REQUIRED
20. Landing Light AS REQUIRED

(Continued on following page)

CIRRUS PILOT'S CHECKLIST MODEL SR22T

- 21. Magnetos..... CHECK Left and Right RPM drop must not exceed 150 RPM for either magneto. RPM differential must not exceed 75 RPM between magnetos.
 - a. Ignition Switch..... R, note RPM, then BOTH
 - b. Ignition Switch..... L, note RPM, then BOTH
- 22. Engine Parameters..... CHECK
- 23. Power Lever 1000 RPM
- 24. Flight Instruments, HSI, and Altimeter..... CHECK & SET
- 25. Flight Controls FREE & CORRECT
- 26. Trim..... SET Takeoff
- 27. Autopilot..... DISCONNECT

If Icing Conditions are Anticipated Immediately After Takeoff:
- 28. ICE PROTECT System Switch..... ON
- 29. ICE PROTECT Mode Switch..... NORM / HIGH
- 30. PITOT HEAT Switch ON
- 31. Cabin Heat..... HOT
- 32. Windshield Defrost ON
- 33. Ice-Inspection Lights..... AS REQUIRED
- 34. Verify airframe is free of contamination immediately before takeoff.
- 35. Flaps..... RETRACT as soon as practical

BEFORE TAKEOFF

CIRRUS PILOT'S CHECKLIST MODEL SR22T

Normal Takeoff

1. Brakes RELEASE (Steer with Rudder Only)
2. Power Lever FULL FORWARD
3. Engine ParametersCHECK
4. Elevator Control ROTATE Smoothly at 77-80 KIAS
5. At 90 KIAS, Flaps UP

Short Field Takeoff

1. Flaps 50%
2. Brakes HOLD
3. Power Lever FULL FORWARD
4. Engine ParametersCHECK
5. Brakes RELEASE (Steer with Rudder Only)
6. Elevator Control ROTATE Smoothly at 77 KIAS
7. Airspeed at Obstacle 85 KIAS

Full Power Climb: Rich of Peak Technique

1. OxygenAS REQUIRED
2. Power Lever FULL FORWARD
3. Mixture Maintain Fuel Flow in GREEN ARC
4. Flaps Verify UP
5. Airspeed 120 KIAS
6. Fuel PumpBOOST
7. Fuel Flow MONITOR
8. Engine Parameters MONITOR

Cruise Climb: Lean of Peak Technique

1. Power LeverREDUCE to 30.5 in.Hg
2. MixtureLEAN to cyan target or less
3. Minimum Airspeed 120 KIAS
4. Fuel PumpBOOST
5. Oxygen AS REQUIRED

(Continued on following page)

CIRRUS PILOT'S CHECKLIST MODEL SR22T

- a. Oxygen Masks/Cannulas DON
- b. Oxygen System..... ON
- c. Flow Rate ADJUST for planned cruise altitude
- d. Flowmeters and Quantity MONITOR
- 6. Cylinder Head Temperatures MONITOR

Icing Conditions: In Flight

If Icing Conditions Exist:

- 1. PITOT HEAT Switch Verify ON
- 2. ICE PROTECT System Switch..... ON
- 3. ICE PROTECT Mode Switch..... NORM / HIGH
- 4. WIND SHLD Push-Button..... PRESS AS REQUIRED
- 5. Monitor ice accumulation.

If ice accumulation occurs:

- a. ICE PROTECT Mode HIGH

If ice continues accumulating:

- b. ICE PROTECT Mode Push-ButtonMAX

If ice accretions do not shed:

- c. PUMP BKUP Switch ON
- d. Perform Anti-Ice System Failure Checklist.

Inadvertent Icing Encounter:

- 1. PITOT HEAT Switch Verify ON
- 2. ICE PROTECT System Switch..... ON
 - a. ICE PROTECT Mode Push-ButtonMAX
to initially dissipate ice accumulation, then
 - b. ICE PROTECT Mode Switch HIGH / NORM
If excess ice accumulation occurs, then:
 - c. ICE PROTECT Mode Push-ButtonMAX
If ice does not shed, perform Anti-ice System Failure Checklist.
- 3. WIND SHLD Push-Button..... PRESS AS REQUIRED
- 4. Airspeed MAINTAIN 95-177 KIAS
or less than 204 KTAS

ICING

Icing Conditions: In Flight

While in Icing Conditions:

1. FLAPS UP
2. Ice-Inspection Lights.....AS REQUIRED
3. Cabin Heat.....HOT
4. Windshield Defrost ON
5. Deicing Fluid Quantity MONITOR
 - a. Ensure adequate quantity to complete flight.

After Leaving Icing Conditions:

1. Anti-Ice System OFF
2. Airspeed as flight CONDITIONS DICTATE
3. Ice-Inspection Lights.....AS REQUIRED
4. Cabin Heat.....AS REQUIRED
5. Windshield DefrostAS REQUIRED
6. WIND SHLD Push-Button..... PRESS AS REQUIRED

Cruise

1. Oxygen AS REQUIRED
2. Cruise Altitude ESTABLISHED
3. Power Lever REDUCE to 30.5 in.Hg or less
4. Fuel PumpAS REQUIRED

• Note •

The Fuel Pump must be set to BOOST during maneuvering flight (i.e. flight training maneuvers, chandelles, stalls, etc.).

5. Mixture ADJUST
6. Engine Parameters MONITOR
7. Fuel Flow and Balance MONITOR

If any CHTs exceed 420°F:

8. Mixture LEAN 0.5 GPH and MONITOR

(Continued on following page)

ICING
CRUISE

CIRRUS PILOT'S CHECKLIST MODEL SR22T

If Icing Conditions are Encountered During Cruise:

- 9. Perform Checklist Icing Conditions - In Flight
- 10. Engine Power INCREASE to maintain cruise speed
- 11. Autopilot.....As Required
Disconnect every 30 minutes to detect any out-of-trim conditions.
When disconnecting the autopilot with ice accretions on the airplane, the pilot should be alert for out-of-trim forces.

Descent

- 1. Oxygen AS REQUIRED
- 2. Altimeter SET
- 3. Cabin Heat/DefrostAS REQUIRED
- 4. Landing Light..... ON
- 5. Fuel System.....CHECK
- 6. Power LeverAS REQUIRED

For Rapid Descent:

- a. Power Lever Smoothly REDUCE MAP 18 to 20 in.Hg
- 7. MixtureAS REQUIRED

For Rapid Descent:

- a. MixtureMaintain CHTs above 240°F
- 8. Brake PressureCHECK

If Icing Conditions Exist:

- 1. ICE PROTECT System Switch ON
- 2. ICE PROTECT Mode Switch HIGH
- 3. Monitor ice accumulation.

If ice continues to accumulate:

- a. ICE PROTECT Mode Push-ButtonMAX

If ice does not shed:

- b. PUMP BKUP Switch ON
- c. Perform Deicing System Failure Checklist.
- 4. WIND SHLD Push-Button..... PRESS AS REQUIRED
- 5. Ice-Inspection Lights.....AS REQUIRED
- 6. Flaps..... 50%
- 7. AirspeedMinimum of 95 KIAS
- 8. Airspeed on Short Final 88 KIAS

CRUISE
DESCENT

CIRRUS PILOT'S CHECKLIST MODEL SR22T

Before Landing

1. Seat Belt and Shoulder Harness SECURE
2. Fuel Pump BOOST
3. Mixture FULL RICH
4. Flaps AS REQUIRED
5. Autopilot AS REQUIRED

Normal Landing

1. Flaps 100%
2. Airspeed 80-85 KIAS
If Icing Conditions Exist:
 - a. Airspeed on Short Final 88 KIAS
3. Power Lever AS REQUIRED
After touchdown:
4. Brakes AS REQUIRED

Short Field Landing

1. Flaps 100%
2. Airspeed 79 KIAS
3. Power Lever AS REQUIRED
After clear of obstacles:
4. Power Lever REDUCE TO IDLE
After touchdown:
5. Brakes MAXIMUM

Balked Landing/Go-Around

1. Autopilot DISENGAGE
2. Power Lever FULL FORWARD
3. Flaps 50%
4. Airspeed 80-85 KIAS
After clear of obstacles:
5. Flaps UP

CIRRUS PILOT'S CHECKLIST MODEL SR22T

After Landing

- 1. Power Lever 1000 RPM
- 2. Fuel Pump OFF or BOOST
- 3. Mixture LEAN to obtain maximum idle RPM
- 4. Flaps UP
- 5. Transponder STBY
- 6. Lights AS REQUIRED
- 7. PITOT HEAT Switch OFF
- 8. ICE PROTECT System Switch OFF
- 9. PUMP BKUP Switch OFF
- 10. Ice-Inspection Lights OFF

Shutdown

- 1. Fuel Pump (if used) OFF
- 2. Throttle IDLE
- 3. Ignition Switch CYCLE
- 4. Mixture CUTOFF
- 5. All Switches OFF
- 6. Magnetos OFF
- 7. ELT TRANSMIT LIGHT OUT
- 8. Chocks, Tie-downs, Pitot Covers AS REQUIRED

SHUTDOWN

Oxygen Duration (Precise Flight System)

Oxygen System Usage Duration - A4 Flowmeter

(STD) Standard Cannula/Mask - (OXY) Oxymiser Annual

Tested Values at Altitude for flow rates STPD

(77 Cu. Ft. Serviced to 1,800 PSIG -5%), Flow Rates are For Reference Only

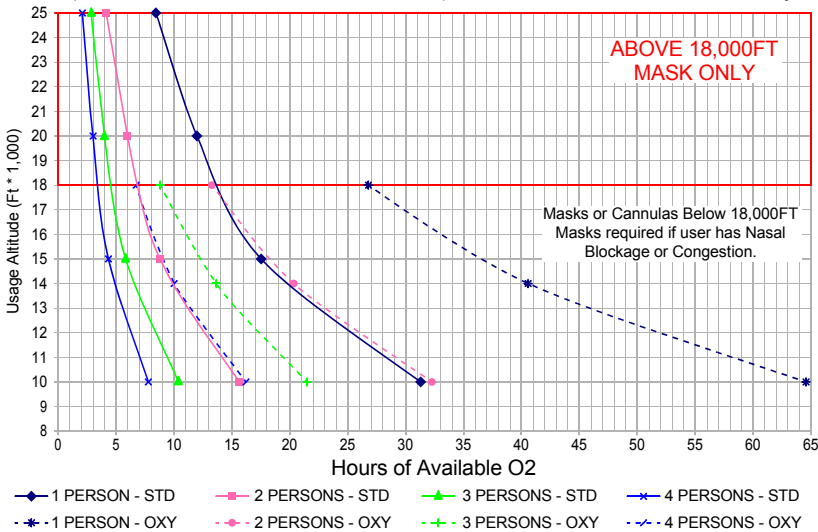

Oxygen System Usage Duration - A5 Flowmeter

(STD) Standard Cannula/Mask - (OXY) Oxymiser Annual

Tested Values at Altitude for flow rates STPD

(77 Cu. Ft. Serviced to 1,800 PSIG -5%), Flow Rates are For Reference Only

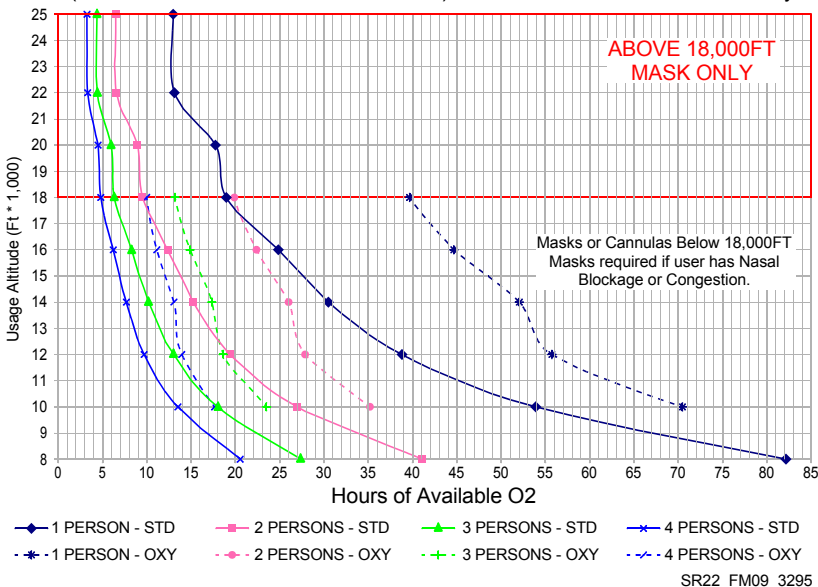

O2 DURATION

SR22_FM09_3295

CIRRUS PILOT'S CHECKLIST MODEL SR22T

PERF

Performance Table of Contents

Takeoff Distance: 3600 LB.....P-1
 Takeoff Distance: 2900 LB.....P-2
 Cruise PerformanceP-3
 Landing Distance - Flaps 100%P-5
 Landing Distance - Flaps 50%P-6
 Landing Distance - Flaps 0%P-7
 Stall Speeds with Ice AccumulationP-8
 Cruise Performance with Ice AccumulationP-9
 Landing Distance with Ice AccumulationP-11
 Wind ComponentsP-12
 Weight and BalanceP-13
 Loading CalculationsP-13
 Loading DataP-14
 Moment LimitsP-14
 Temperature ConversionP-15

• Note •

Aircraft with optional Air Conditioning System; Brake Horsepower is reduced by approximately 6 BHP.

CIRRUS PILOT'S CHECKLIST MODEL SR22T

Takeoff Distance: 3600 LB

Weight: 3600 LB
Approx. Speed at Liftoff: 80 KIAS
Speed over 50 Ft. Obstacle: 85 KIAS
Flaps: 50%
Power: Full Throttle, Mixture Set
Runway: Dry, Paved, Level

Headwind: Subtract 10% for each 12 knots headwind.
Tailwind: Add 10% for each 2 knots tailwind up to 10 knots.
Dry Grass: Add 15% of ground roll to distances.
Runway Slope: Reference Caution.
Air Conditioner: Add 100' to ground roll and 150' to distance over 50' obstacle if Air Conditioner if ON during takeoff.

PRESS ALT FT	DISTANCE FT	TEMPERATURE ~°C						
		0	10	20	30	40	50	ISA
SL	Grnd Roll	1352	1461	1574	1692	1814	1941	1517
	Total	1865	2007	2154	2307	2465	2629	2080
1000	Grnd Roll	1443	1559	1680	1805	1936	2071	1595
	Total	1980	2131	2288	2450	2618	2792	2178
2000	Grnd Roll	1540	1664	1793	1927	2066	2210	1677
	Total	2104	2264	2431	2603	2782	2967	2281
3000	Grnd Roll	1645	1777	1914	2058	2206	2361	1764
	Total	2236	2407	2584	2767	2958	3154	2390
4000	Grnd Roll	1757	1898	2045	2198	2357	2522	1856
	Total	2378	2559	2748	2943	3146	3355	2505
5000	Grnd Roll	1878	2029	2186	2350	2520	2696	1954
	Total	2530	2723	2924	3132	3347	3570	2627
6000	Grnd Roll	2008	2170	2338	2513	2694	2883	2058
	Total	2693	2899	3113	3334	3564	3802	2756
7000	Grnd Roll	2149	2322	2501	2688	2883	3084	2168
	Total	2868	3088	3315	3552	3796	4050	2892
8000	Grnd Roll	2300	2485	2678	2878	3086	3302	2284
	Total	3056	3290	3533	3785	4046	4316	3036
9000	Grnd Roll	2463	2661	2868	3082	3305	3536	2408
	Total	3258	3508	3767	4036	4314	4603	3188
10000	Grnd Roll	2640	2852	3073	3303	3541	3789	2540
	Total	3476	3742	4019	4306	4603	4911	3350

CIRRUS PILOT'S CHECKLIST MODEL SR22T

Takeoff Distance: 2900 LB

Weight: 2900 LB Approx. Speed at Liftoff: 67 KIAS Speed over 50 Ft. Obstacle: 72 KIAS Flaps: 50% Power: Full Throttle, Mixture Set Runway: Dry, Paved, Level		Headwind: Subtract 10% for each 12 knots headwind. Tailwind: Add 10% for each 2 knots tailwind up to 10 knots. Dry Grass: Add 15% of ground roll to distances. Runway Slope: Reference Caution. Air Conditioner: Add 100' to ground roll and 150' to distance over 50' obstacle if Air Conditioner if ON during takeoff.						
PRESS ALT FT	DISTANCE FT	TEMPERATURE ~°C						
		0	10	20	30	40	50	ISA
SL	Grnd Roll	485	524	564	606	650	695	544
	Total	766	823	882	944	1007	1073	852
1000	Grnd Roll	517	559	602	647	694	742	571
	Total	812	872	935	1000	1068	1138	891
2000	Grnd Roll	552	596	642	690	740	792	601
	Total	861	925	992	1061	1133	1207	932
3000	Grnd Roll	589	637	686	737	791	846	632
	Total	914	982	1053	1126	1202	1281	975
4000	Grnd Roll	630	680	733	788	845	904	665
	Total	970	1043	1118	1196	1277	1360	1021
5000	Grnd Roll	673	727	783	842	903	966	700
	Total	1030	1108	1188	1271	1357	1446	1069
6000	Grnd Roll	720	778	838	900	965	1033	737
	Total	1095	1177	1262	1351	1442	1537	1120
7000	Grnd Roll	770	832	896	963	1033	1105	777
	Total	1164	1252	1343	1437	1534	1634	1174
8000	Grnd Roll	824	890	959	1031	1106	1183	819
	Total	1239	1332	1428	1529	1632	1739	1231
9000	Grnd Roll	883	954	1028	1104	1184	1267	863
	Total	1318	1418	1521	1627	1738	1852	1291
10000	Grnd Roll	946	1022	1101	1183	1269	1358	910
	Total	1404	1510	1620	1733	1851	1973	1354

TAKEOFF

CIRRUS PILOT'S CHECKLIST MODEL SR22T

Cruise Performance

Conditions:

- Weight..... 3400 LB
- Winds Zero

• Note •

Subtract 10 KTAS if nose wheel pant and fairing removed. Lower KTAS by 10% if nose and main wheel pants and fairings are removed.

Aircraft with optional Air Conditioning System: Cruise performance is reduced by 2 knots. For maximum performance, turn air conditioner off.

Aircraft with optional Enhanced Vision System: Cruise performance is reduced by up to 1 knot.

The values shown in gray in the table below may not be achievable for temperature management reasons. This data is provided for purposes of interpolating between points.

CRUISE PERFORMANCE			ISA -30°C		ISA		ISA +30°C	
Altitude (ft MSL)	Power (% of 315)	FF (GPH)	TAS (KTAS)	Econ (nm/gal)	TAS (KTAS)	Econ (nm/gal)	TAS (KTAS)	Econ (nm/gal)
2000	85%	18.3	164	9.0	170	9.3	176	9.6
	75%	16.4	157	9.6	162	9.9	167	10.2
	65%	14.6	148	10.2	154	10.5	158	10.8
	55%	12.7	138	10.9	143	11.2	147	11.5
4000	85%	18.3	168	9.1	174	9.5	179	9.8
	75%	16.4	160	9.7	165	10.1	170	10.4
	65%	14.6	151	10.3	156	10.7	161	11.0
	55%	12.7	140	11.0	145	11.4	149	11.8
6000	85%	18.3	171	9.3	177	9.7	183	10.0
	75%	16.4	163	9.9	168	10.2	174	10.6
	65%	14.6	153	10.5	159	10.9	163	11.2
	55%	12.7	143	11.2	147	11.6	152	11.9
8000	85%	18.3	174	9.5	180	9.8	186	10.2
	75%	16.4	166	10.1	171	10.4	177	10.8
	65%	14.6	156	10.7	161	11.1	166	11.4
	55%	12.7	145	11.4	150	11.8	154	12.1
10000	85%	18.3	177	9.7	184	10.0	190	10.4
	75%	16.4	169	10.3	175	10.6	180	11.0
	65%	14.6	159	10.9	164	11.3	169	11.6
	55%	12.7	148	11.6	152	12.0	157	12.3
12000	85%	18.3	181	9.9	187	10.2	193	10.6
	75%	16.4	172	10.4	178	10.8	183	11.2
	65%	14.6	162	11.1	167	11.5	172	11.8
	55%	12.7	150	11.8	155	12.2	159	12.5

CIRRUS PILOT'S CHECKLIST MODEL SR22T

CRUISE PERFORMANCE			ISA -30°C		ISA		ISA +30°C	
Altitude (ft MSL)	Power (% of 315)	FF (GPH)	TAS (KTAS)	Econ (nm/gal)	TAS (KTAS)	Econ (nm/gal)	TAS (KTAS)	Econ (nm/gal)
14000	85%	18.3	184	10.0	191	10.4	197	10.8
	75%	16.4	175	10.6	181	11.0	187	11.4
	65%	14.6	165	11.3	170	11.7	175	12.0
	55%	12.7	153	12.0	157	12.4	162	12.7
16000	85%	18.3	187	10.2	194	10.6	201	11.0
	75%	16.4	178	10.8	185	11.2	191	11.6
	65%	14.6	167	11.5	173	11.9	179	12.2
	55%	12.7	155	12.2	160	12.6	164	12.9
18000	85%	18.3	191	10.4	198	10.8	205	11.0
	75%	16.4	181	11.0	188	11.4	194	11.8
	65%	14.6	171	11.7	176	12.1	182	12.5
	55%	12.7	158	12.4	162	12.8	167	13.1
20000	85%	18.3	195	10.6	202	11.0	209	11.4
	80%	17.4	190	10.9	197	11.3	204	11.7
	75%	16.4	185	11.2	192	11.7	198	12.0
	65%	14.6	174	11.9	180	12.3	185	12.7
	55%	12.7	160	12.6	165	13.0	169	13.3
22000	85%	18.3	199	10.8	206	11.3	213	11.6
	80%	17.4	194	11.1	201	11.6	208	12.0
	75%	16.4	188	11.5	195	11.9	202	12.3
	65%	14.6	177	12.1	183	12.5	188	12.9
	55%	12.7	163	12.8	168	13.2	172	13.5
24000	85%	18.3	202	11.1	210	11.5	218	11.9
	80%	17.4	197	11.4	205	11.8	212	12.2
	75%	16.4	192	11.7	199	12.1	206	12.5
	65%	14.6	180	12.3	186	12.8	191	13.1
	55%	12.7	165	13.0	170	13.4	174	13.7
25000	85%	18.3	204	11.2	213	11.6	220	12.0
	80%	17.4	199	11.5	207	11.9	214	12.3
	75%	16.4	194	11.8	201	12.2	208	12.6
	65%	14.6	181	12.4	188	12.9	193	13.2
	55%	12.7	166	13.1	171	13.5	176	13.8

CRUISE

CIRRUS PILOT'S CHECKLIST MODEL SR22T

Landing Distance - Flaps 100%

LANDING

WEIGHT: 3600 LB Speed over 50 Ft Obstacle: 79 KIAS Flaps: 100% Power: Idle Runway: Dry, Paved, Level		Headwind: Subtract 10% for each 13 knots headwind. Tailwind: Add 10% for each 2 knots tailwind up to 10 knots. Runway Slope: Reference Notes Dry Grass: Add 20% to Ground Roll Wet Grass: Add 60% to Ground Roll						
PRESS ALT FT	DISTANCE FT	TEMPERATURE ~°C						
		0	10	20	30	40	50	ISA
SL	Grnd Roll	1117	1158	1198	1239	1280	1321	1178
	Total	2447	2505	2565	2625	2685	2747	2535
1000	Grnd Roll	1158	1200	1243	1285	1327	1370	1213
	Total	2506	2567	2630	2693	2757	2821	2585
2000	Grnd Roll	1201	1245	1289	1333	1377	1421	1250
	Total	2568	2633	2699	2765	2832	2900	2636
3000	Grnd Roll	1246	1292	1337	1383	1428	1474	1287
	Total	2635	2702	2771	2841	2911	2983	2691
4000	Grnd Roll	1293	1340	1388	1435	1482	1530	1326
	Total	2705	2776	2848	2922	2996	3070	2748
5000	Grnd Roll	1342	1391	1440	1489	1539	1588	1367
	Total	2779	2854	2930	3007	3085	3163	2808
6000	Grnd Roll	1393	1444	1495	1546	1598	1649	1409
	Total	2857	2936	3016	3097	3179	3261	2871
7000	Grnd Roll	1447	1500	1553	1606	1659	1712	1453
	Total	2941	3024	3108	3193	3279	3365	2937
8000	Grnd Roll	1503	1558	1613	1668	1724	1779	1499
	Total	3029	3116	3205	3294	3384	3475	3006
9000	Grnd Roll	1562	1619	1677	1734	1791	1848	1546
	Total	3122	3214	3307	3401	3496	3592	3079
10000	Grnd Roll	1624	1683	1743	1802	1862	1921	1595
	Total	3221	3318	3416	3515	3614	3715	3155

CIRRUS PILOT'S CHECKLIST MODEL SR22T

Landing Distance - Flaps 50%

WEIGHT: 3600 LB Speed over 50 Ft Obstacle: 87 KIAS Flaps: 50% Power: Idle Runway: Dry, Paved, Level		Headwind: Subtract 10% for each 13 knots headwind. Tailwind: Add 10% for each 2 knots tailwind up to 10 knots. Runway Slope: Reference Notes Dry Grass: Add 20% to Ground Roll Wet Grass: Add 60% to Ground Roll						
PRESS ALT FT	DISTANCE FT	TEMPERATURE ~°C						
		0	10	20	30	40	50	ISA
SL	Grnd Roll	1166	1209	1251	1294	1337	1379	1230
	Total	2681	2745	2810	2875	2942	3010	2777
1000	Grnd Roll	1209	1253	1298	1342	1386	1430	1267
	Total	2745	2813	2881	2950	3020	3091	2833
2000	Grnd Roll	1254	1300	1346	1392	1438	1484	1305
	Total	2814	2885	2957	3029	3103	3178	2892
3000	Grnd Roll	1301	1349	1396	1444	1491	1539	1344
	Total	2886	2961	3037	3113	3191	3269	2954
4000	Grnd Roll	1350	1399	1449	1498	1548	1597	1385
	Total	2963	3042	3121	3202	3283	3366	3019
5000	Grnd Roll	1401	1453	1504	1555	1607	1658	1427
	Total	3045	3127	3211	3296	3382	3468	3087
6000	Grnd Roll	1455	1508	1561	1615	1668	1721	1472
	Total	3131	3218	3306	3395	3485	3576	3158
7000	Grnd Roll	1511	1566	1622	1677	1732	1788	1517
	Total	3223	3314	3407	3501	3595	3691	3233
8000	Grnd Roll	1570	1627	1685	1742	1800	1857	1565
	Total	3320	3416	3514	3612	3712	3812	3312
9000	Grnd Roll	1631	1691	1751	1810	1870	1930	1614
	Total	3423	3524	3627	3731	3835	3941	3395
10000	Grnd Roll	1695	1758	1820	1882	1944	2006	1666
	Total	3532	3639	3747	3856	3966	4077	3481

LANDING

CIRRUS PILOT'S CHECKLIST MODEL SR22T

Landing Distance - Flaps 0%

WEIGHT: 3600 LB
Speed over 50 Ft Obstacle: 94 KIAS
Flaps: 0%
Power: Idle
Runway: Dry, Paved, Level

Headwind: Subtract 10% for each 13 knots headwind.
Tailwind: Add 10% for each 2 knots tailwind up to 10 knots.
Runway Slope: Reference Notes
Dry Grass: Add 20% to Ground Roll
Wet Grass: Add 60% to Ground Roll

PRESS ALT FT	DISTANCE FT	TEMPERATURE ~°C						
		0	10	20	30	40	50	ISA
SL	Grnd Roll	1365	1415	1465	1515	1565	1615	1440
	Total	3165	3241	3319	3398	3478	3558	3280
1000	Grnd Roll	1415	1467	1519	1571	1623	1675	1483
	Total	3242	3323	3404	3487	3571	3656	3347
2000	Grnd Roll	1468	1522	1576	1629	1683	1737	1527
	Total	3324	3409	3495	3582	3670	3759	3418
3000	Grnd Roll	1523	1579	1635	1690	1746	1802	1574
	Total	3411	3500	3590	3682	3775	3868	3491
4000	Grnd Roll	1581	1638	1696	1754	1812	1870	1621
	Total	3503	3597	3692	3788	3885	3984	3569
5000	Grnd Roll	1641	1701	1761	1821	1881	1941	1671
	Total	3600	3699	3799	3900	4003	4106	3650
6000	Grnd Roll	1703	1766	1828	1890	1953	2015	1723
	Total	3703	3807	3913	4019	4127	4236	3736
7000	Grnd Roll	1769	1834	1899	1963	2028	2093	1776
	Total	3813	3922	4033	4145	4258	4373	3825
8000	Grnd Roll	1838	1905	1972	2040	2107	2174	1832
	Total	3929	4044	4161	4279	4398	4518	3919
9000	Grnd Roll	1910	1980	2049	2119	2189	2259	1890
	Total	4052	4173	4296	4420	4545	4671	4018
10000	Grnd Roll	1985	2058	2130	2203	2276	2348	1950
	Total	4183	4310	4439	4569	4701	4833	4122

CIRRUS PILOT'S CHECKLIST MODEL SR22T

Performance of the airplane with the TCM TSIO-550-K turbocharged engine installed is equal to or better than the performance described in the following tables.

Stall Speeds with Ice Accumulation

Conditions:

- Weight 3600 LB
- CG Noted
- Power Idle
- Bank Angle Noted

• Note •

Altitude loss during wings level stall may be 600 feet or more.

KIAS values may not be accurate at stall.

Weight	Bank Angle	STALL SPEEDS			
		Flaps 0% Full Up		Flaps 50%	
LB	Deg	KIAS	KCAS	KIAS	KCAS
3600 Most FWD CG	0	77	76	72	69
	15	79	77	73	70
	30	83	82	75	74
	45	91	90	82	82
	60	107	107	95	98
3600 Most AFT CG	0	77	76	72	69
	15	79	77	73	70
	30	83	82	75	74
	45	91	90	82	82
	60	107	107	95	98

ICE PERF
STALL

CIRRUS PILOT'S CHECKLIST MODEL SR22T

Cruise Performance with Ice Accumulation

Conditions:

- Weight..... 3400 LB
- Winds..... Zero

• Note •

Aircraft with optional Air Conditioning System: Cruise performance is reduced by 2 knots. For maximum performance, the air conditioner should be off.

CRUISE PERFORMANCE			ISA -30°C		ISA		ISA +30°C	
Altitude (ft MSL)	Power (% of 315)	FF (GPH)	TAS (KTAS)	Econ (nm/gal)	TAS (KTAS)	Econ (nm/gal)	TAS (KTAS)	Econ (nm/gal)
2000	85%	18.3	149	8.1				
	75%	16.4	138	8.4				
	65%	14.6	123	8.4				
	55%	12.7	104	8.2				
4000	85%	18.3	151	8.2				
	75%	16.4	139	8.4				
	65%	14.6	123	8.4				
	55%	12.7	104	8.2				
6000	85%	18.3	152	8.3				
	75%	16.4	140	8.5				
	65%	14.6	123	8.5				
	55%	12.7	103	8.1				
8000	85%	18.3	154	8.4	162	8.8		
	75%	16.4	141	8.5	148	9.0		
	65%	14.6	124	8.5	131	9.0		
10000	85%	18.3	156	8.5	164	8.9		
	75%	16.4	141	8.6	149	9.1		
	65%	14.6	124	8.5	131	9.0		
12000	85%	18.3	157	8.6	165	9.0		
	75%	16.4	142	8.7	150	9.1		
	65%	14.6	123	8.4	131	9.0		
14000	85%	18.3	158	8.6	167	9.1		
	75%	16.4	142	8.7	151	9.2		
	65%	14.6	123	8.4	131	9.0		
16000	85%	18.3	165	9.0	168	9.2		
	75%	16.4	150	9.1	151	9.2		
	65%	14.6	131	9.0	131	9.0		

ICE PERF CRUISE

CIRRUS PILOT'S CHECKLIST MODEL SR22T

CRUISE PERFORMANCE			ISA -30°C		ISA		ISA +30°C	
Altitude (ft MSL)	Power (% of 315)	FF (GPH)	TAS (KTAS)	Econ (nm/gal)	TAS (KTAS)	Econ (nm/gal)	TAS (KTAS)	Econ (nm/gal)
18000	85%	18.3	167	9.1	169	9.2		
	75%	16.4	151	9.2	151	9.2		
	65%	14.6	131	9.0				
20000	85%	18.3	168	9.2	170	9.3		
	80%	17.4	160	9.2	161	9.3		
	75%	16.4	151	9.2	151	9.2		
	65%	14.6	131	8.9				
22000	85%	18.3	169	9.2	171	9.3		
	80%	17.4	161	9.3	162	9.3		
	75%	16.4	151	9.2	151	9.2		

ICE PERF
CRUISE

CIRRUS PILOT'S CHECKLIST MODEL SR22T

Landing Distance with Ice Accumulation

• Note •

Sloped Runway - Increase distances by 27% of ground roll distance for each 1% downslope. Decrease distances by 9% of ground roll distance for each 1% upslope.

WEIGHT: 3600 LB						Headwind: Subtract 10% for each 13 knots headwind.
Speed over 50 Ft Obstacle: 88 KIAS						Tailwind: Add 10% for each 2 knots tailwind up to 10 knots.
Flaps: 50%						Runway Slope: Reference Notes
Power: Smooth power reduction from obstacle to idle at touchdown.						Dry Grass: Add 20% to Ground Roll
Runway: Dry, Paved, Level						Wet Grass: Add 60% to Ground Roll
PRESS ALT FT	DISTANCE FT	TEMPERATURE ~°C				ISA
		-20	-10	0	5	
SL	Grnd Roll	1356	1409	1463	1489	
	Total	2833	2908	2984	3022	
1000	Grnd Roll	1406	1461	1517	1544	
	Total	2903	2981	3061	3101	
2000	Grnd Roll	1458	1516	1573	1602	
	Total	2977	3059	3143	3185	
3000	Grnd Roll	1513	1572	1632	1662	
	Total	3055	3142	3229	3274	
4000	Grnd Roll	1570	1632	1694	1725	
	Total	3138	3229	3321	3367	
5000	Grnd Roll	1629	1694	1758	1790	
	Total	3225	3321	3418	3466	
6000	Grnd Roll	1692	1758	1825	1859	
	Total	3318	3418	3520	3571	
7000	Grnd Roll	1757	1826	1896	1930	
	Total	3416	3522	3628	3682	
8000	Grnd Roll	1825	1897	1969	2005	1963
	Total	3520	3631	3743	3800	3583
9000	Grnd Roll	1896	1971	2046	2084	2025
	Total	3630	3746	3864	3924	3656
10000	Grnd Roll	1971	2049	2127	2166	2089
	Total	3746	3869	3993	4055	3733

CIRRUS PILOT'S CHECKLIST MODEL SR22T

Wind Components

Conditions:

- Runway Heading 10°
- Wind Direction 60°
- Wind Velocity 15 Knots

Example: (See Chart ▶ ▶ ▶)

- Wind/Flight Path Angle 50°
- Crosswind Component 12 Knots
- Headwind Component 10 Knots

• Note •

The maximum demonstrated crosswind is 21 knots. Value not considered limiting.

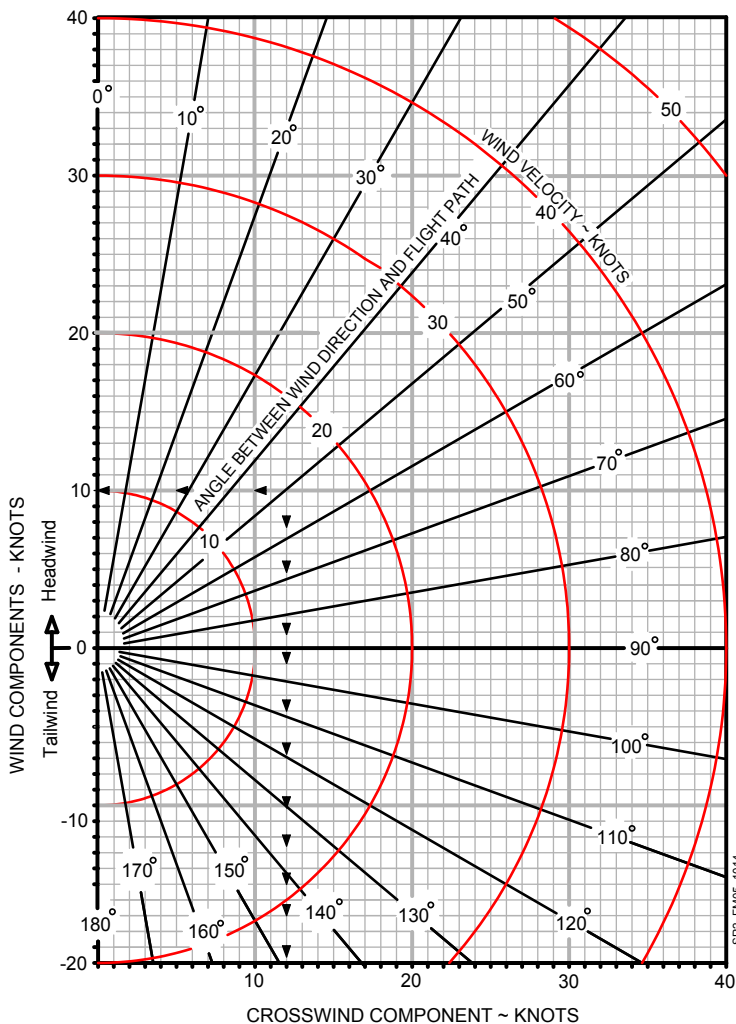

WIND
CMPNNTS

CIRRUS PILOT'S CHECKLIST MODEL SR22T

Weight and Balance

Loading Calculations

For Moment/1000, refer to Loading Data table on following page.

Description	Weight	Moment/1000
1. Empty Weight <i>Includes unusable fuel and full oil</i>		
2. Front Seats Occupants <i>Pilot and Passenger</i>		
3. Rear Seats Occupants		
4. Baggage <i>130 lb maximum</i>		
5. Zero Fuel Condition <i>Subtotal items 1 thru 4 3400 lb maximum</i>		
6. Fuel Load <i>92 Gallon @6.0 lb/gal. maximum</i>		
7. Ramp Weight <i>Subtotal items 5 and 6</i>		
8. Fuel for start, taxi, and runup <i>Normally 9 lb at avg. mmnt of 1394.1</i>	-	-
9. Takeoff Weight <i>Subtract Item 8 from item 7</i>		

Calculation Instructions

- Enter the current basic empty weight and moment from the aircraft's Weight and Balance Record.
- Enter the total weight and moment/1000 for the front seat occupants from the adjacent Loading Data Table.
- Enter the total weight and moment/1000 for the rear seat occupants from the adjacent Loading Data Table.
- Enter the total weight and moment/1000 for the baggage from the adjacent Loading Data Table.
- If desired, subtotal the weight and moment/1000 entries from steps 1 - 4.
- Enter the weight and moment/1000 of usable fuel loaded on the airplane.
- Subtotal the weight and moment/1000.
- Enter values for typical start, taxi, and run-up operations of 9 pounds at an average moment/1000 of 1.394.
- Subtract step 8 weight and moment/1000 from the Ramp Weight to determine the Takeoff Weight and moment/1000.
 - Verify Takeoff Weight does not exceed the 3600 pounds.
 - Verify Moment/1000 falls between the interpolated minimum and maximum values listed on the adjacent Moment Limits Table.

CIRRUS PILOT'S CHECKLIST MODEL SR22T

Loading Data

Use this table to determine the Moment/1000.

Weight LB	Fwd Pass FS 143.5	Aft Pass FS 180.0	Baggage FS 208.0	Fuel FS 154.9	Weight LB	Fwd Pass FS 143.5	Aft Pass FS 180.0	Fuel FS 154.9
20	2.9	3.6	4.2	3.1	300	43.1	54.0	46.5
40	5.7	7.2	8.3	6.2	320	45.9	57.6	49.6
60	8.6	10.8	12.5	9.3	340	48.8	61.2	52.7
80	11.5	14.4	16.6	12.4	360	51.7	64.8	55.8
100	14.4	18.0	20.8	15.5	380	54.5	68.4	58.9
120	17.2	21.6	25.0	18.6	400	57.4	72.0	62.0
140	20.1	25.2	27.04*	21.7	420	60.3	75.6	65.1
160	23.0	28.8		24.8	440	63.1	79.2	68.2
180	25.8	32.4		27.9	460			71.3
200	28.7	36.0		31.0	480			74.4
220	31.6	39.6		34.1	500			77.5
240	34.4	43.2		37.2	520			80.5
260	37.3	46.8		40.3	552**			85.5
280	40.2	50.4		43.4	*130 lb Maximum **92 U.S. Gallons Usable			

Moment Limits

Use this table to determine if Loading Calculations are within limits.

Weight LB	Moment/1000		Weight LB	Moment/1000	
	Minimum	Maximum		Minimum	Maximum
2200	304	326	2950	414	437
2250	311	333	3000	422	444
2300	318	341	3050	430	452
2350	325	348	3100	438	459
2400	332	356	3150	445	467
2450	340	363	3200	453	474
2500	347	370	3250	461	481
2550	354	378	3300	469	489
2600	361	385	3350	477	496
2650	368	393	*3400	484	504
2700	375	400	3450	494	511
2750	383	407	3500	501	519
2800	391	415	3550	508	526
2850	399	422	3600	515	533
2900	407	430			

*NOTE: Maximum zero fuel weight

CIRRUS PILOT'S CHECKLIST MODEL SR22T

Temperature Conversion

To convert from Celsius (°C) to Fahrenheit (°F), find, in the shaded columns, the number representing the temperature value (°C) to be converted. The equivalent Fahrenheit temperature is read to the right.

► EXAMPLE: 38°C = 100°F.

To convert from Fahrenheit (°F) to Celsius (°C), find in the shaded columns area, the number representing the temperature value (°F) to be converted. The equivalent Celsius temperature is read to the left.

► EXAMPLE: 38°F = 3°C.

Temp to Convert °C or °F			Temp to Convert °C or °F			Temp to Convert °C or °F		
°C	◀ ▶	°F	°C	◀ ▶	°F	°C	◀ ▶	°F
-50	-58	-72	-17	2	36	17	62	144
-49	-56	-69	-16	4	39	18	64	147
-48	-54	-65	-14	6	43	19	66	151
-47	-52	-62	-13	8	46	20	68	154
-46	-50	-58	-12	10	50	21	70	158
-44	-48	-54	-11	12	54	22	72	162
-43	-46	-51	-10	14	57	23	74	165
-42	-44	-47	-9	16	61	24	76	169
-41	-42	-44	-8	18	64	26	78	172
-40	-40	-40	-7	20	68	27	80	176
-39	-38	-36	-6	22	72	28	82	180
-38	-36	-33	-4	24	75	29	84	183
-37	-34	-29	-3	26	79	30	86	187
-36	-32	-26	-2	28	82	31	88	190
-34	-30	-22	-1	30	86	32	90	194
-33	-28	-18	0	32	90	33	92	198
-32	-26	-15	1	34	93	34	94	201
-31	-24	-11	2	36	97	36	96	205
-30	-22	-8	3	38	100	37	98	208
-29	-20	-4	4	40	104	38	100	212
-28	-18	0	6	42	108	39	102	216
-27	-16	3	7	44	111	40	104	219
-26	-14	7	8	46	115	41	106	223
-24	-12	10	9	48	118	42	108	226
-23	-10	14	10	50	122	43	110	230
-22	-8	18	11	52	126	44	112	234
-21	-6	21	12	54	129	46	114	237
-20	-4	25	13	56	133	47	116	241
-19	-2	28	14	58	136	48	118	244
-18	0	32	16	60	140	49	120	248

TEMP
CONVERT

CIRRUS PILOT'S CHECKLIST MODEL SR22T

**Abnormal Procedures
Table of Contents**

Perspective Crew Alerting System (CAS) Index

CAS Message	Page	CAS Message	Page
OIL PRESS	A-3	PITOT HEAT FAIL	A-9
MAN PRESSURE	A-3	PITOT HEAT REQD	A-9
START ENGAGE	A-3	FLAPS	A-10
ALT AIR OPEN	A-4	BRAKE TEMP	A-11
FUEL QTY	A-5	OXYGEN QTY	A-12
L FUEL QTY	A-5	OXYGEN RQD	A-12
R FUEL QTY	A-5	OXYGEN QTY	A-12
FUEL IMBALANCE	A-5	ANTI ICE QTY	A-13
M BUS 1	A-6	AOA OVERHEAT	A-13
M BUS 2	A-6	ANTI ICE PSI	A-14
BATT 1	A-6	ANTI ICE PSI	A-14
ALT 1	A-7	ANTI ICE SPD	A-14
ALT 2	A-7	ANTI ICE LVL	A-15
AVIONICS OFF	A-8	ANTI ICE HTR	A-15
PFD FAN FAIL	A-8	PARK BRAKE	A-16
MFD FAN FAIL	A-8		

Flight EnvironmentA-1
 Inadvertent Icing Encounter.....A-1
 Inadvertent IMC Encounter.....A-1
 Door Open In FlightA-1
 Abnormal LandingsA-2
 Landing With Failed Brakes.....A-2
 Landing With Flat TireA-2
 Engine SystemA-3
 Low Idle Oil PressureA-3
 Manifold Pressure HighA-3
 Starter EngagedA-3
 Alternate Air Door Open AnnunciationA-4
 Fuel SystemA-5
 Low Fuel Quantity.....A-5
 Left OR Right Fuel Tank QuantityA-5

CIRRUS PILOT'S CHECKLIST MODEL SR22T

Abnormal Procedures

Table of Contents

Fuel Imbalance	A-5
Electrical System.....	A-6
Low Voltage on Main Bus 1	A-6
Low Voltage on Main Bus 2	A-6
Battery 1 Current Sensor	A-6
Low Alternator 1 Output	A-7
Low Alternator 2 Output.....	A-7
Integrated Avionics System.....	A-8
Avionics Switch Off.....	A-8
PFD Cooling Fan Failure	A-8
MFD Cooling Fan Failure	A-8
Flight Displays Too Dim.....	A-8
Pitot Static System	A-9
Pitot Static Malfunction	A-9
Pitot Heat Current Sensor Annunciation.....	A-9
Pitot Heat Required Annunciation	A-9
Flight Control System.....	A-10
Electric Trim/Autopilot Failure.....	A-10
Flap System Exceedance	A-10
Landing Gear System	A-11
Brake Failure During Taxi.....	A-11
Left/Right Brake Over-Temperature	A-11
Oxygen System.....	A-12
Oxygen Quantity Low	A-12
Anti-Ice System	A-13
Windshield De-Ice System Malfunction	A-13
Heated Lift Transducer Malfunction.....	A-13
Low Fluid Quantity Caution	A-13
Lift Transducer Overheat Warning	A-13
Persistent Low Pressure Caution	A-14
High Pressure Caution	A-14
Speed Caution.....	A-14
Left/Right Anti-Ice Fluid Level Caution	A-15
Stall Warning / AOA Heater Failure Caution	A-15
Other Conditions	A-16
Aborted Takeoff.....	A-16
Parking Brake Engaged Annunciation.....	A-16
Communications Failure.....	A-16

CIRRUS PILOT'S CHECKLIST MODEL SR22T

Flight Environment

Inadvertent Icing Encounter

- 1. Pitot Heat..... ON
- 2. Exit icing conditions..... Turn back or change altitude.
- 3. Cabin Heat..... MAXIMUM
- 4. Windshield Defrost FULL OPEN

Inadvertent IMC Encounter

- 1. Airplane Control..... ESTABLISH straight and level flight
- 2. Autopilot..... ENGAGE to hold heading and altitude
- 3. Heading RESET to initiate 180° turn

Door Open In Flight

- 1. Airplane Control..... MAINTAIN

IN FLIGHT

CIRRUS PILOT'S CHECKLIST MODEL SR22T

Abnormal Landings

Landing With Failed Brakes

One brake inoperative

1. Land on the side of runway corresponding to the inoperative brake.
2. Maintain directional control using rudder and working brake.

Both brakes inoperative

1. Divert to the longest, widest runway with the most direct headwind.
2. Land on downwind side of the runway.
3. Use the rudder for obstacle avoidance.
4. Perform *Emergency Engine Shutdown on Ground Checklist*.

Landing With Flat Tire

Main Gear

1. Land on the side of the runway corresponding to the good tire.
2. Maintain directional control with the brakes and rudder.
3. Do not taxi. Stop the airplane and perform a normal engine shutdown.

Nose Gear

1. Land in the center of the runway.
2. Hold the nosewheel off the ground as long as possible.
3. Do not taxi. Stop the airplane and perform a normal engine shutdown.

CIRRUS PILOT'S CHECKLIST MODEL SR22T

Engine System

Low Idle Oil Pressure

OIL PRESS

- 1. If In-Flight..... LAND AS SOON AS PRACTICAL

Manifold Pressure High

MAN PRESSURE

- 1. Power LeverREDUCE to less than 36.5"
- 2. Flight.....CONTINUE
If noticeable surging is present:
- 3. Complete Overboost / Pressure Relief Valve Emergency Checklist

Starter Engaged

START ENGAGE

On-Ground

- 1. Ignition SwitchDISENGAGE prior to 10 Seconds
- 2. Battery Switches Wait 20 seconds before next start attempt
If starter does not disengage (relay or solenoid failure):
- 3. BAT 1 Switch OFF
- 4. Engine SHUTDOWN
- 5. STARTER Circuit breaker PULL

In-Flight

- 1. Ignition Switch Ensure not stuck in START
- 2. STARTER Circuit breaker PULL
- 3. Flight.....CONTINUE

ENGINE

Alternate Air Door Open Annunciation

ALT AIR OPEN

1. Manifold Pressure.....CHECK
If environment suspect as cause (icing or visible debris):
2. Flight Conditions CHANGE/EXIT
3. PowerReduce to 30.5 in.Hg when practical
4. Flight.....CONTINUE

ENGINE

Fuel System

Low Fuel Quantity

FUEL QTY

1. Fuel Quantity Gages.....CHECK
If fuel quantity indicates less than or equal to 14 gallons:
 - a. Land as soon as practical.*If fuel quantity indicates more than 14 gallons:*
 - a. FlightCONTINUE, MONITOR

Left OR Right Fuel Tank Quantity

Conduct the following procedure if either of the annunciators listed below are displayed on the MFD.

L FUEL QTY	R FUEL QTY
-------------------	-------------------

1. Indicated (L or R) Fuel Quantity Gage.....CHECK
If fuel quantity indicates less than or equal to 14 gallons:
 - a. If On-Ground REFUEL PRIOR TO FLIGHT
 - b. If In-FlightCONTINUE, MONITOR*If fuel quantity indicates more than 14 gallons:*
 - a. If On-Ground CORRECT PRIOR TO FLIGHT
 - b. If In-FlightCONTINUE, MONITOR

Fuel Imbalance

FUEL IMBALANCE

1. Fuel Quantity Gages.....CHECK
2. Fuel PumpBOOST
If HIGH BOOST already in use for vapor suppression, pump should be left in this position for tank switch.
3. Fuel Selector SELECT FULLEST TANK
4. Fuel PumpAS REQUIRED
 - a. *After switching tanks, message will remain until sensed imbalance is less than 10 gallons.*

FUEL

Electrical System

Low Voltage on Main Bus 1

M BUS 1

1. Perform Alt 1 Caution (Failure) Checklist.

Low Voltage on Main Bus 2

M BUS 2

1. Perform Alt 1 and Alt 2 Caution (Failure) Checklists.

Battery 1 Current Sensor

BATT 1

1. Main Bus 1, 2 and Non-Essential Bus Loads REDUCE
2. Main Bus 1, 2 and Essential Bus Voltages MONITOR
3. Land as soon as practical.

Low Alternator 1 Output

ALT 1

1. ALT 1 Circuit Breaker CHECK & SET
2. ALT 1 Master Switch..... CYCLE
If alternator does not reset (low A1 Current and M1 voltage):
3. ALT 1 Master Switch..... OFF
4. Non-Essential Bus Loads REDUCE
 - a. If flight conditions permit, consider shedding the following to preserve Battery 1:
 - (1) Air Conditioning,
 - (2) Landing Light,
 - (3) Yaw Servo,
 - (4) Convenience Power (aux items plugged into armrest jack)
5. Continue Flight, avoiding IMC or night flight as able.

Low Alternator 2 Output

ALT 2

1. ALT 2 Circuit Breaker CHECK & SET
2. ALT 2 Master Switch..... CYCLE
If alternator does not reset (low A2 Current and M2 voltage less than M1 voltage):
3. ALT 2 Master Switch..... OFF
4. Continue Flight, avoiding IMC or night flight as able (reduced power redundancy).

ELECTRIC

Integrated Avionics System

Avionics Switch Off

AVIONICS OFF

- 1. AVIONICS Switch ON, AS REQUIRED

PFD Cooling Fan Failure

PFD FAN FAIL

- 1. AVIONICS FAN 2 Circuit Breaker CYCLE
If annunciation does not extinguish:
 - a. Hot cabin temperatures..... LAND AS SOON AS PRACTICAL
 - b. Cool cabin temperaturesCONTINUE, MONITOR

MFD Cooling Fan Failure

MFD FAN FAIL

- 1. AVIONICS FAN 1 Circuit Breaker CYCLE
If annunciation does not extinguish:
 - a. High cabin temperatures LAND AS SOON AS PRACTICAL
 - b. Low cabin temperaturesCONTINUE, MONITOR

Flight Displays Too Dim

- 1. INSTRUMENT dimmer knobOFF (full counter-clockwise)
If flight displays do not provide sufficient brightness:
- 2. Revert to standby instruments.

AVIONICS

CIRRUS PILOT'S CHECKLIST MODEL SR22T

Pitot Static System

Pitot Static Malfunction

Static Source Blocked

- 1. Pitot Heat..... ON
- 2. Alternate Static Source..... OPEN

Pitot Tube Blocked

- 1. Pitot Heat..... ON

Pitot Heat Current Sensor Annunciation

PITOT HEAT FAIL

- 1. Pitot Circuit Breaker..... CYCLE
- 2. Pitot Heat..... CYCLE OFF, ON

If inadvertent icing encountered, perform Inadvertent Icing Encounter Emergency Checklist and:

- a. Airspeed..... EXPECT NO RELIABLE INDICATION
- b. Exit icing conditions using attitude, altitude, and power instruments.

Pitot Heat Required Annunciation

PITOT HEAT REQD

- 1. Pitot Heat..... ON

PITOT-STATIC

CIRRUS PILOT'S CHECKLIST MODEL SR22T

Flight Control System

Electric Trim/Autopilot Failure

1. Airplane Control MAINTAIN MANUALLY
2. Autopilot (if engaged) DISENGAGE
If Problem Is Not Corrected:
3. Circuit BreakersPULL AS REQUIRED
 - PITCH TRIM
 - ROLL TRIM
 - YAW SERVO
 - AP SERVOS
4. Power LeverAS REQUIRED
5. Control Yoke MANUALLY HOLD PRESSURE
6. Land as soon as practical.

Flap System Exceedance

FLAPS

1. Airspeed REDUCE
or
1. Flaps RETRACT

CIRRUS PILOT'S CHECKLIST MODEL SR22T

Landing Gear System

Brake Failure During Taxi

- 1. Engine PowerAS REQUIRED
- 2. Directional Control MAINTAIN WITH RUDDER
- 3. Brake Pedal(s)..... PUMP
If directional control can not be maintained:
- 4. Ignition Switch OFF

Left/Right Brake Over-Temperature

BRAKE TEMP

- 1. Stop aircraft and allow the brakes to cool.

Oxygen System

Oxygen Quantity Low

OXYGEN QTY Caution

OXYGEN QTY

1. Oxygen Pressure and Flow Rate.....CHECK
2. Oxygen Duration..... CALCULATE
 - a. See Performance Tab - Oxygen Duration: calculate duration based on remaining pressure, number of occupants and type of device (mask or cannula).
3. Perform Normal Descent as necessary, dependant on duration calculation.
4. Annunciation indicated tank pressure is between 800 and 400 PSI. See Performance Tab - Oxygen Duration.

OXYGEN RQD Caution

OXYGEN RQD

1. Oxygen Masks or Cannulas DON
2. Oxygen System ON
3. Oxygen Flow RateADJUST as necessary for cruise altitude

OXYGEN QTY Advisory

OXYGEN QTY

On-Ground

1. Oxygen SupplyREPLENISH if use of oxygen is anticipated

In-Flight

1. If use of oxygen is anticipated, verify adequate oxygen supply for flight duration. See Performance Tab - Oxygen Duration.

Anti-Ice System

Windshield De-Ice System Malfunction

1. ICE PROTECT A Circuit Breaker CYCLE
2. Fluid Quantity SWITCH TO FULLEST TANK
3. WIND SHLD Push-Button..... PRESS AS REQUIRED
If the forward field of view is overly restricted during landing approach and taxiing:
 - a. Cabin HeatHOT
 - b. Windshield Defrost..... ON
 - c. Execute a forward slip as required for visibility.
 - d. Avoid taxiing without adequate forward visibility.

Heated Lift Transducer Malfunction

If ice forms on lift transducer vane:

1. STALL VANE HEAT Circuit Breaker CYCLE
2. PITOT HEAT Switch CYCLE OFF, ON

If ice remains on lift transducer vane:

1. Stall Warning System..... EXPECT NO RELIABLE INDICATION
This includes:
 - Impending stall warning.
 - Stall speed indication.
2. AirspeedMONITOR, DO NOT STALL
3. Fly published V_{REF} speeds..... Minimum 88 KIAS with 50% Flap

Low Fluid Quantity Caution

ANTI ICE QTY

1. Icing Conditions AVOID / EXIT

Lift Transducer Overheat Warning

AOA OVERHEAT

1. PITOT HEAT Switch OFF
2. Icing Conditions AVOID / EXIT

ICING

Persistent Low Pressure Caution

ANTI ICE PSI

1. ICE PROTECT A and B Circuit Breakers SET
2. Anti-Ice - TKS Quantity SWITCH TO FULLEST TANK
3. WIND SHLD Push-Button..... PRESS
 - a. Repeat operation of windshield pump to verify system is primed properly as evidenced by anti-ice fluid exiting windshield nozzles.
4. ICE PROTECT Mode Switch HIGH
If caution annunciation extinguishes:
 - a. Anti-Ice System MONITOR
If caution annunciation does not extinguish or intermittent:
 - a. PUMP BKUP Switch ON
 - b. Icing Conditions..... AVOID / EXIT

High Pressure Caution

ANTI ICE PSI

1. Evidence of Anti-Ice Flow MONITOR / VERIFY
2. Icing Conditions AVOID / EXIT

Speed Caution

ANTI ICE SPD

1. Airspeed MAINTAIN 95-177 KIAS
 or less than 204 KTAS.

ICING

Left/Right Anti-Ice Fluid Level Caution

ANTI ICE LVL

1. Revert to manual control of the fluid source to control the fluid level quantity.
If ANTI ICE FLO or ANTI ICE PSI annunciates:
 - a. Switch to opposite tank.
 - b. WIND SHLD Push-Button PRESS
 - (1) Repeat operation of windshield pump to verify system is primed properly as evidenced by anti-ice fluid exiting windshield nozzles.

Stall Warning / AOA Heater Failure Caution

ANTI ICE HTR

1. STALL VANE HEAT Circuit Breaker CYCLE
2. PITOT HEAT Circuit Breaker CYCLE
3. Icing Conditions AVOID / EXIT
4. Fly aircraft normally using airframe buffet as the stall warning. Ice accumulations on the stall warning vane may result in unreliable stall warning system operation.

CIRRUS PILOT'S CHECKLIST MODEL SR22T

Other Conditions

Aborted Takeoff

- 1. Power Lever IDLE
- 2. BrakesAS REQUIRED

Parking Brake Engaged Annunciation

PARK BRAKE

- 1. Parking BrakeRELEASE
- 2. Monitor CAS for BRAKE TEMP Caution. Stop aircraft and allow the brakes to cool if necessary.

Communications Failure

- 1. Switches, ControlsCHECK
- 2. Frequency CHANGE
- 3. Circuit Breakers SET
- 4. Headset CHANGE
- 5. Hand Held MicrophoneCONNECT

OTHER

CIRRUS PILOT'S CHECKLIST MODEL SR22T

EMERGENCY

**Emergency Procedures
Table of Contents**

Perspective Crew Alerting System (CAS) Index

CAS Message	Page	CAS Message	Page
OIL PRESS	E-7	ESS BUS	E-13
OIL TEMP	E-7	CO LVL HIGH	E-14
CHT	E-8	OXYGEN FAULT	E-15
MAN PRESSURE	E-9	OXYGEN QTY	E-15
TIT	E-9	ANTI ICE FLO	E-17
FUEL QTY	E-10	ANTI ICE CTL	E-17
FUEL IMBALANCE	E-10	ANTI ICE QTY	E-17
RPM	E-11	AOA OVERHEAT	E-17
M BUS 1	E-12	BRAKE TEMP	E-20
M BUS 2	E-12	START ENGAGE	E-20

Airspeeds for Emergency Operations E-1

 Maximum Glide..... E-1

 Memory Items..... E-1

Engine Failures E-2

 Engine Failure On Takeoff (Low Altitude)..... E-2

 Engine Failure In Flight..... E-2

Airstart..... E-3

 Engine Airstart..... E-3

Smoke and Fire..... E-4

 Cabin Fire In Flight E-4

 Engine Fire In Flight E-4

 Wing Fire In Flight E-5

 Engine Fire During Start..... E-5

 Smoke and Fume Elimination..... E-5

Emergency Descent..... E-6

 Emergency Descent E-6

Forced Landing E-6

 Emergency Landing Without Engine Power E-6

 Ditching..... E-6

 Landing Without Elevator Control..... E-6

Engine System E-7

 Engine Partial Power Loss E-7

 Oil Pressure Out of Range E-7

 Oil Temperature High E-7

 High Cylinder Head Temperature..... E-8

Turbocharger System Emergencies E-8

 Unexpected Loss Of Manifold Pressure..... E-8

CIRRUS PILOT'S CHECKLIST MODEL SR22T

Emergency Procedures

Table of Contents

Manifold Pressure High	E-9
Overboost / Pressure Relief Valve	E-9
Turbine Inlet Temperature High.....	E-9
EGT, TIT or CHT Temperature Sensor Failure	E-9
Fuel System Emergencies	E-10
Low Fuel Quantity.....	E-10
Fuel Imbalance	E-10
Propeller System Emergencies.....	E-11
Engine Speed High.....	E-11
Propeller Governor Failure	E-11
Electrical System Emergencies.....	E-12
High Voltage on Main Bus 1	E-12
High Voltage on Main Bus 2	E-12
High or Low Voltage on Essential Bus	E-13
Environmental System Emergencies	E-14
Carbon Monoxide Level High	E-14
Oxygen System Emergencies.....	E-15
Oxygen System Fault - Above 10,000 Ft.....	E-15
Oxygen Quantity Low	E-15
Anti-Ice System	E-16
Anti-Ice System Failure / Excessive Ice Accumulation	E-16
Low Flow Rate Warning	E-17
Tank Control Failure Warning.....	E-17
Low Fluid Quantity Warning	E-17
AOA Probe Overheat Warning	E-17
Integrated Avionics System Emergencies.....	E-18
Attitude & Heading Reference System (AHRS) Failure.....	E-18
Air Data Computer (ADC) Failure.....	E-18
PFD Display Failure.....	E-18
Unusual Attitude Emergencies	E-19
Inadvertent Spin Entry	E-19
Inadvertent Spiral Dive During IMC Flight	E-19
Other Emergencies	E-19
Power Lever Linkage Failure.....	E-19
Emergency Engine Shutdown On Ground	E-19
Left/Right Brake Over-Temperature	E-20
Starter Engaged	E-20
Emergency Ground Egress	E-20
CAPS Deployment	E-21
Circuit Breaker Panel	E-22

CIRRUS PILOT'S CHECKLIST MODEL SR22T

AIRSPEEDS

Airspeeds for Emergency Operations

Maneuvering Speed:

3600 lb 140 KIAS

Best Glide:

All Weights 92 KIAS

Emergency Landing (Engine-out):

Flaps Up 90 KIAS

Flaps 50% 85 KIAS

Flaps 100% 80 KIAS

Maximum Glide

Best Glide Speed 92 KIAS at 3600 lb

Maximum Glide Ratio ~ 8.6 : 1

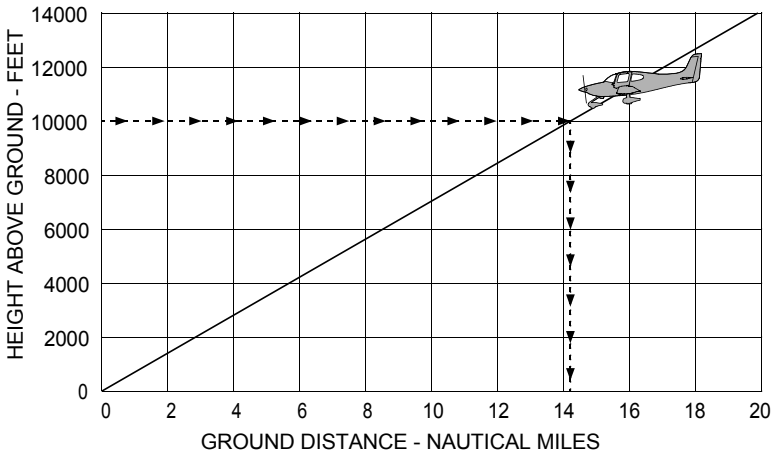

SR22_FM03_3564

• Note •

Maximum Glide Ratio with Ice Accumulation ~ 6.4: 1

Memory Items

Checklist steps emphasized by underlining such as the example below, should be memorized for accomplishment without reference to the procedure.

1. Best Glide Speed ESTABLISH

CIRRUS PILOT'S CHECKLIST MODEL SR22T**Engine Failures****Engine Failure On Takeoff (Low Altitude)**

1. Best Glide or Landing Speed (as appropriate) ESTABLISH
2. Mixture CUTOFF
3. Fuel Selector OFF
4. Ignition Switch OFF
5. Flaps AS REQUIRED

If time permits:

6. Power Lever IDLE
7. Fuel Pump OFF
8. Bat-Alt Master Switches OFF
9. Seat Belts ENSURE SECURED

Engine Failure In Flight

1. Best Glide Speed ESTABLISH
2. Fuel Selector SWITCH TANKS
3. Ignition Switch CHECK, BOTH
4. Fuel Pump BOOST
5. Power Lever ½ OPEN
6. Mixture... IDLE CUTOFF then slowly ADVANCE until engine starts

If engine does not start:

7. Perform Engine Airstart or Emergency Landing Without Engine Power Checklist, as required.

If engine starts:

8. CHTs and Oil Temperature VERIFY within GREEN range, warm engine at partial power if required.

CIRRUS PILOT'S CHECKLIST MODEL SR22T

Airstart

Engine Airstart

1. Bat Master Switches..... ON
2. Power Lever OPEN ½ INCH
3. Mixture RICH, AS REQ'D
4. Fuel Selector SWITCH TANKS
5. Ignition Switch BOTH
6. Fuel Pump BOOST
7. Alt Master Switches OFF
8. Starter (Propeller not Windmilling) ENGAGE
9. Power Lever slowly INCREASE
10. Alt Master Switches ON
11. CHTs and Oil Temperature VERIFY within GREEN range,
warm engine at partial power if required.
12. If engine will not start, perform *Forced Landing* Checklist.

AIRSTART

CIRRUS PILOT'S CHECKLIST MODEL SR22T**Smoke and Fire****Cabin Fire In Flight**

1. Bat-Alt Master SwitchesOFF, AS REQ'D

2. Fire Extinguisher..... ACTIVATE

If airflow is not sufficient to clear smoke or fumes from cabin:

3. Cabin Doors..... PARTIALLY OPEN

4. Avionics Power Switch..... OFF

5. All other switches..... OFF

6. Land as soon as possible.

If setting master switches off eliminated source of fire or fumes and airplane is in night, weather, or IFR conditions:

7. Airflow Selector..... OFF

8. Bat-Alt Master Switches ON

9. Avionics Power Switch..... ON

10. Required Systems ACTIVATE one at a time

11. Temperature Selector COLD

12. Vent Selector FEET/PANEL/DEFROST POSITION

13. Airflow Selector.....SET AIRFLOW TO MAXIMUM

14. Panel Eyeball Outlets OPEN

15. Land as soon as possible.

Engine Fire In Flight

1. Mixture.....CUTOFF

2. Fuel Pump OFF

3. Fuel Selector OFF

4. Airflow Selector..... OFF

5. Power Lever IDLE

6. Ignition Switch OFF

7. Cabin Doors..... PARTIALLY OPEN

8. Land as soon as possible.

CIRRUS PILOT'S CHECKLIST MODEL SR22T

Wing Fire In Flight

1. Pitot Heat Switch OFF
2. Navigation Light Switch OFF
3. Landing Light OFF
4. Strobe Light Switch OFF
5. If possible, side slip to keep flames away from fuel tank and cabin.
6. Land as soon as possible.

Engine Fire During Start

1. Mixture CUTOFF
2. Fuel Pump OFF
3. Fuel Selector OFF
4. Power Lever ADVANCE
5. Starter CRANK
6. If flames persist, perform *Emergency Engine Shutdown on Ground* and *Emergency Ground Egress* Checklists.

Smoke and Fume Elimination

1. Oxygen Masks or Cannulas DON
 2. Oxygen System ON
 3. Oxygen Flow Rate MAXIMUM
 4. Air Conditioner (if installed) OFF
 5. Temperature Selector COLD
 6. Vent Selector FEET/PANEL/DEFROST POSITION
 7. Airflow Selector SET AIRFLOW TO MAXIMUM
- If source of smoke and fume is firewall forward:*
- a. Airflow Selector OFF
8. Panel Eyeball Outlets OPEN
 9. Prepare to land as soon as possible.

SMOKE
AND FIRE

CIRRUS PILOT'S CHECKLIST MODEL SR22T**Emergency Descent****Emergency Descent**

1. Power Lever IDLE
2. Mixture AS REQUIRED
3. Airspeed V_{NE} (205 KIAS)

Forced Landing**Emergency Landing Without Engine Power**

1. Best Glide Speed ESTABLISH
2. Radio Transmit (121.5 MHz) MAYDAY
giving location and intentions
3. Transponder SQUAWK 7700
4. If off airport, ELT ACTIVATE
5. Power Lever IDLE
6. Mixture CUTOFF
7. Fuel Selector OFF
8. Ignition Switch OFF
9. Fuel Pump OFF
10. Flaps (when landing is assured) 100%
11. Master Switches OFF
12. Seat Belt(s) SECURED

Ditching

1. Radio Transmit (121.5 MHz) MAYDAY
giving location and intentions
2. Transponder SQUAWK 7700
3. CAPS ACTIVATE
4. Airplane EVACUATE
5. Flotation Devices INFLATE WHEN CLEAR OF AIRPLANE

Landing Without Elevator Control

1. Flaps SET 50%
2. Trim SET 80 KIAS
3. Power AS REQUIRED FOR GLIDE ANGLE

CIRRUS PILOT'S CHECKLIST MODEL SR22T

Engine System

Engine Partial Power Loss

1. Air Conditioner (if installed) OFF
2. Fuel Pump HIGH BOOST/PRIME
3. Fuel Selector SWITCH TANKS
4. MixtureCHECK appropriate for flight conditions
5. Power Lever SWEEP
6. Ignition SwitchBOTH, L, then R
7. Land as soon as practical.

Oil Pressure Out of Range

OIL PRESS

1. Oil Pressure GageCHECK
If pressure low/high:
 - a. Power REDUCE to minimum for sustained flight
 - b. Land as soon as possible.
 - (1) Prepare for potential engine failure.

Oil Temperature High

OIL TEMP

1. Power REDUCE
2. Airspeed INCREASE
3. Mixture ADJUST fuel flow to top of green arc
4. Oil Temperature Gage MONITOR
If temperature remains high:
5. Land as soon as possible.

ENGINE

CIRRUS PILOT'S CHECKLIST MODEL SR22T

High Cylinder Head Temperature

CHT

On-Ground

1. Power Lever REDUCE
2. Annunciations and Engine Temperatures MONITOR
If Caution or Warning annunciation is still illuminated:
3. Power Lever MINIMUM REQUIRED
4. Flight PROHIBITED

In-Flight

1. Power Lever REDUCE
2. Mixture ADJUST fuel flow to top of green arc
3. Airspeed INCREASE
4. Annunciations and Engine Temperatures MONITOR
If Caution or Warning annunciation is still illuminated:
5. Power Lever MINIMUM REQUIRED
6. Engine Instruments MONITOR
If Caution annunciation only remains illuminated:
 - a. Land as soon as practical.*If Warning annunciation remains illuminated:*
 - a. Land as soon as possible.

Turbocharger System Emergencies

Unexpected Loss Of Manifold Pressure

1. Power ADJUST to minimum required for sustained flight
2. Mixture ADJUST for EGTs between 1300° to 1400°F
3. Descend to MINIMUM SAFE ALTITUDE from which a landing may be safely accomplished.
4. Divert to nearest suitable airfield.
5. Radio Advise ATC landing is urgent or Transmit (121.5 MHz) MAYDAY giving location and intentions when workload permits.
6. Oil Pressure MONITOR
7. Land as soon as possible.

CIRRUS PILOT'S CHECKLIST MODEL SR22T**Manifold Pressure High****MAN PRESSURE**

1. Power LeverREDUCE MAP to less than 36.5 in.Hg
2. Flight.....CONTINUE
If noticeable surging is present:
3. Perform Overboost / Pressure Relief Valve Checklist.

Overboost / Pressure Relief Valve

1. Power Lever REDUCE to 30.5 in.Hg or less
2. Mixture.....ADJUST fuel flow to top of green arc
If continued surging is present:
3. Land as soon as practical.

Turbine Inlet Temperature High**TIT**

1. Mixture.....ADJUST Fuel Flow to Top of Green Arc
2. Ignition SwitchCHECK on BOTH
If TIT remains in excess of limits:
 - a. Power..... REDUCE
 - b. Land as soon as practical.

EGT, TIT or CHT Temperature Sensor Failure

1. Similar gages..... MONITOR
2. Flight.....CONTINUE
using remaining gages as representative.

TURBO-
CHARGER

Fuel System Emergencies

Low Fuel Quantity

FUEL QTY

- 1. Fuel Quantity Gages.....CHECK
If fuel quantity indicates less than or equal to 9 gallons:
 - a. Land as soon as practical.*If fuel quantity indicates more than 9 gallons:*
 - a. FlightCONTINUE, MONITOR

Fuel Imbalance

FUEL IMBALANCE

- 1. Fuel Quantity Gages.....CHECK
- 2. Fuel PumpBOOST
If HIGH BOOST already in use for vapor suppression, pump should be left in this position for tank switch.
- 3. Fuel Selector SELECT FULLEST TANK
- 4. Fuel PumpAS REQUIRED
After switching tanks, message will remain until sensed imbalance is less than 12 gallons.

FUEL

CIRRUS PILOT'S CHECKLIST MODEL SR22T**Propeller System Emergencies****Engine Speed High****RPM**

1. Power LeverREDUCE by 2 in.Hg Manifold Pressure
If governor is not in control (RPM reduces and remains lower after power adjustment):
2. Perform *Propeller Governor Failure* Checklist.
If governor is in control (RPM remains high, but stable after power reduction):
3. Power Lever . REDUCE below 34 in.Hg for climb, below 30.5in.Hg for cruise.
If governed engine speed exceeds 2600 RPM:
4. Perform Propeller Governor Failure Checklist.
If governed engine speed is 2600 RPM or less:
5. Flight.....CONTINUE

Propeller Governor Failure

1. Power LeverReduce to minimum necessary for sustained flight
2. AirspeedReduce to 85-90 KIAS
3. Oil Pressure..... MONITOR
4. Land as soon as possible.

PROPELLER

Electrical System Emergencies**High Voltage on Main Bus 1****M BUS 1**

1. ALT 1 Master Switch..... CYCLE
2. M Bus 1 Voltage (M1).....CHECK
If M Bus 1 Voltage is greater than 32 volts:
3. ALT 1 Master Switch..... OFF
4. Perform Alt 1 Caution (Failure) Checklist (do not reset alternator)

High Voltage on Main Bus 2**M BUS 2**

1. Main Bus 1 Voltage (M1)CHECK
If M Bus 1 Voltage is greater than 32 volts:
2. Perform M Bus 1 Warning Checklist
3. Main Bus 2 Voltage (M2)CHECK
If M Bus 2 Voltage is greater than 32 volts:
4. ALT 2 Master Switch..... CYCLE
5. Main Bus 2 Voltage (M2)CHECK
If M Bus 2 Voltage remains greater than 32 volts:
6. ALT 2 Master Switch..... OFF
7. Perform Alt 2 Caution (Failure) Checklist (do not reset alternator).

CIRRUS PILOT'S CHECKLIST MODEL SR22T

High or Low Voltage on Essential Bus

ESS BUS

1. Essential Bus Voltage (ESS) CHECK
If Essential Bus Voltage is greater than 32 volts:
2. Main Bus 1 and Main Bus 2 Voltages (M1 and M2) CHECK
3. Perform appropriate *Main Bus 1* or *Main Bus 2* Warning Checklists.
If Essential Bus Voltage is less than 24.5 volts:
4. Perform Alt 1 and Alt 2 Caution (Failure) Checklists.
If unable to restore at least one alternator:
5. Non-Essential Loads REDUCE
 - a. If flight conditions permit, consider shedding:
Air Conditioning, Landing Light, Pitot Heat, Cabin Fan, Nav Lights, Strobe Lights, Audio Panel, COM 2, Yaw Damper.
6. Land as soon as practical (Battery reserve only).

CIRRUS PILOT'S CHECKLIST MODEL SR22T

Environmental System Emergencies

Carbon Monoxide Level High

CO LVL HIGH

1. Air Conditioner (if installed).....NOT IN RECIRC MODE
 2. Temperature Selector COLD
 3. Vent Selector FEET/PANEL/DEFROST POSITION
 4. Airflow Selector.....SET AIRFLOW TO MAXIMUM
 5. Panel Eyeball Outlets OPEN
- If CO LVL HIGH does not extinguish:*
6. Supplemental Oxygen (if available)
 - a. Oxygen Masks or Cannulas DON
 - b. Oxygen System..... ON
 - c. Oxygen Flow Rate..... MAXIMUM
 7. Land as soon as possible.

CIRRUS PILOT'S CHECKLIST MODEL SR22T**Oxygen System Emergencies****Oxygen System Fault - Above 10,000 Ft****OXYGEN FAULT**

1. Oxygen Flow RateCHECK
If no flow:
2. Initiate Emergency Descent to below 10,000 ft:
 - a. Power Lever IDLE
 - b. MixtureAS REQUIRED
 - c. Airspeed VNE (205 KIAS)*If flow is normal:*
3. Oxygen Flow Rate MONITOR
4. Initiate Normal Descent as soon as practical.
Below 10,000 ft:
5. Oxygen System OFF
6. Flight.....CONTINUE
Remain below altitudes requiring supplemental oxygen.

Oxygen Quantity Low**OXYGEN QTY**

1. Oxygen Pressure and Flow Rate.....CHECK
2. Initiate Normal Descent (non-emergency) below 10,000 ft.
3. Oxygen Flow Rate MONITOR
Below 10,000 ft:
4. Flight.....CONTINUE
Remain below altitudes requiring supplemental oxygen.

OXYGEN

CIRRUS PILOT'S CHECKLIST MODEL SR22T

Anti-Ice System

Anti-Ice System Failure / Excessive Ice Accumulation

1. ICE PROTECT A and B Circuit Breakers SET
2. Fluid Quantity SWITCH TO FULLEST TANK
3. WIND SHLD Push-Button..... PRESS
 - a. Repeat operation of windshield pump to verify metering pumps are primed properly as evidenced by deicing fluid exiting windshield nozzles.
4. ICE PROTECT Mode Switch VERIFY HIGH
5. PUMP BKUP Switch ON

If determined windshield pump is not priming:
6. Exit Icing Conditions Immediately.
7. Airspeed95 KIAS OR GREATER

Maintain a minimum airspeed of 95 KIAS or higher to stay above pre-stall buffet. If unable to maintain this airspeed, allow altitude to decrease in order to maintain 95 KIAS.
8. Minimum Approach Speed w/ Residual Ice (Flaps 50%)... 88 KIAS

In severe icing conditions, it may not be possible to maintain altitude or proper glide path on approach; in this case, it is imperative that a safe airspeed be maintained, the stall warning system may not function and there may be little or no pre-stall buffet with heavy ice loads on the wing.
9. FLAPS MINIMUM REQUIRED

When landing is assured, select the minimum flap setting required, not to exceed 50%, and maintain extra airspeed consistent with available field length. Do not retract the flaps once they have been extended unless required for go-around.

CIRRUS PILOT'S CHECKLIST MODEL SR22T

Low Flow Rate Warning

ANTI ICE FLO

1. ICE PROTECT A and B Circuit Breakers SET
2. Fluid Quantity SWITCH TO FULLEST TANK
3. WIND SHLD Push-Button..... PRESS
 - a. Repeat operation of windshield pump to verify metering pumps are primed properly as evidenced by deicing fluid exiting windshield nozzles.
4. ICE PROTECT Mode Switch..... HIGH

If warning annunciation extinguishes:

 - a. Anti-Ice System MONITOR

If warning annunciation does not extinguish or intermittent:

 - a. PUMP BKUP Switch ON
 - b. Icing Conditions..... AVOID / EXIT

Tank Control Failure Warning

ANTI ICE CTL

1. Icing Conditions AVOID / EXIT

Low Fluid Quantity Warning

ANTI ICE QTY

1. Icing Conditions AVOID / EXIT

AOA Probe Overheat Warning

AOA OVERHEAT

1. PITOT HEAT Switch OFF
2. Icing Conditions AVOID / EXIT

CIRRUS PILOT'S CHECKLIST MODEL SR22T

Integrated Avionics System Emergencies

Attitude & Heading Reference System (AHRS) Failure

1. Verify Avionics System has switched to functioning AHRS.
If not, manually switch to functioning AHRS and attempt to bring failed AHRS back on-line:
2. Failed AHRS Circuit Breaker SET
If open, reset (close) circuit breaker. If circuit breaker opens again, do not reset.
3. Be prepared to revert to Standby Instruments (Altitude, Heading).

Air Data Computer (ADC) Failure

1. ADC Circuit Breaker SET
If open, reset (close) circuit breaker. If circuit breaker opens again, do not reset.
2. Revert to Standby Instruments (Altitude, Airspeed).
3. Land as soon as practical.

PFD Display Failure

1. Display Backup ACTIVATE
2. Land as soon as practical.

CIRRUS PILOT'S CHECKLIST MODEL SR22T

Unusual Attitude Emergencies

Inadvertent Spin Entry

1. CAPS..... ACTIVATE

Inadvertent Spiral Dive During IMC Flight

1. Power Lever IDLE
2. Stop the spiral dive by using coordinated aileron and rudder control while referring to the attitude indicator and turn coordinator to level the wings.
3. Cautiously apply elevator back pressure to bring airplane to level flight attitude.
4. Trim for level flight.
5. Set power as required.
6. Use autopilot if functional otherwise maintain a constant heading through the coordinated aileron and rudder inputs.
7. Exit IMC conditions as soon as possible.

Other Emergencies

Power Lever Linkage Failure

1. Power Lever Movement..... VERIFY
2. Power SET if able
3. Flaps..... SET if needed
4. Mixture AS REQUIRED (full rich to cut-off)
5. Land as soon as possible.

Emergency Engine Shutdown On Ground

1. Power Lever IDLE
2. Fuel Pump (if used) OFF
3. Mixture CUTOFF
4. Fuel Selector OFF
5. Ignition Switch OFF
6. Bat-Alt Master Switches OFF

SPINS AND
OTHER

CIRRUS PILOT'S CHECKLIST MODEL SR22T

Left/Right Brake Over-Temperature

BRAKE TEMP

1. Stop aircraft and allow the brakes to cool.

Starter Engaged

START ENGAGE

On-Ground

1. Ignition Switch DISENGAGE
2. Battery Switches Wait 1 minute before next start attempt
If starter does not disengage (relay or solenoid failure):
3. BAT 1 Switch OFF
4. Engine SHUTDOWN
5. STARTER Circuit breaker PULL

In-Flight

1. Ignition Switch Ensure not stuck in START
2. STARTER Circuit breaker PULL
3. Flight CONTINUE
Engine start will not be available at destination.

Emergency Ground Egress

1. Engine SHUTDOWN
2. Seat belts RELEASE
3. Airplane EXIT

CIRRUS PILOT'S CHECKLIST MODEL SR22T**CAPS Deployment****• WARNING •**

The maximum demonstrated deployment speed is 140 KIAS.

1. Activation Handle Cover REMOVE
2. Activation Handle (Both Hands) PULL STRAIGHT DOWN

After Deployment as time permits:

3. Mixture CUTOFF
4. Fuel Selector OFF
5. Fuel Pump OFF
6. Bat-Alt Master Switches OFF
Turn the Bat-Alt Master Switches off after completing any necessary radio communications.
7. Ignition Switch OFF
8. ELT ON
9. Seat Belts and Harnesses TIGHTEN
10. Loose Items SECURE
11. Assume emergency landing body position.
12. After the airplane comes to a complete stop, evacuate quickly and move upwind.

Circuit Breaker Panel

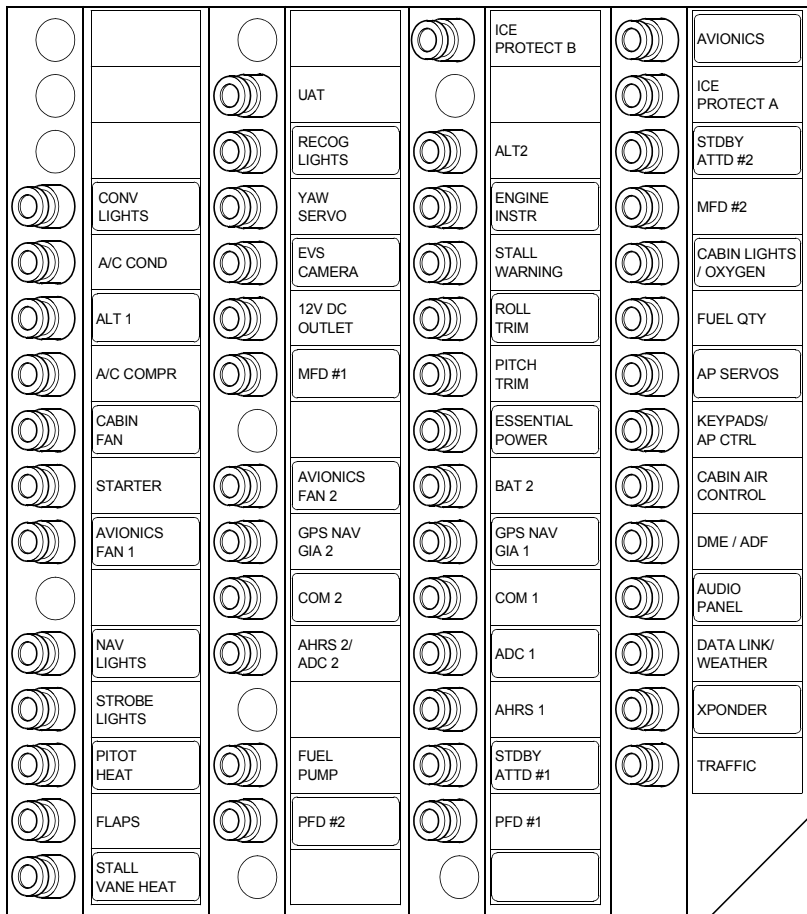

SR22_FM07_4247